

Architectural_01

ilmas

Architectural Collection

Volume 01_2024 IT/EN

Product Book



Otto

La nuova linea di proiettori Otto, interamente sviluppata e prodotta da Ilmas, è stata concepita per integrarsi con tutti i binari presenti nel nostro catalogo. Grazie a un'attenta fase progettuale, i proiettori Otto offrono affidabilità, durabilità e prestazioni di alto livello. Otto dispone di una vasta gamma di accessori e un'ampia selezione di fasci luminosi.

The new Otto track floodlight family, entirely developed and manufactured by Ilmas, is designed to integrate with all tracks in our catalogue. Thanks to a careful design, Otto floodlights offer reliability, durability, and high performances. They are completed by a wide range of accessories and a variety of light beams.



Magic spot

Magic spot è la nuova gamma di proiettori per binario Magic48 che, con elegante flessibilità, offre differenti opzioni di fasci e finiture per adattarsi perfettamente a ogni contesto.

Magic Spot is a new family of Magic48 track lights that offers elegant flexibility, with different beam options and finishes suitable to any context.

Three new recessed light families

Ilmas introduce tre nuove famiglie di incassi: Dot, Isi e Gear, ciascuna progettata per soddisfare diverse esigenze applicative. Dot, dalle dimensioni particolarmente compatte, è ideale per l'illuminazione puntuale. Isi, arricchito da accessori tecnici e decorativi, è pensato per l'ambito residenziale e per strutture ricettive, offrendo particolare comfort visivo grazie alla fonte luminosa recessata. Gear è ideale per ambienti che richiedono un elevato grado di protezione IP e necessitano di una sorgente luminosa orientabile. Grazie alla vasta gamma di accessori disponibili, Gear si distingue per comfort visivo e versatilità.

Ilmas has introduced three new families of recessed lights: Dot, Isi, and Gear. Each family is designed to meet different application needs. Dot is particularly compact and indicated for spot lighting. Isi is enriched with technical and decorative accessories, making it ideal for residential and hospitality environments, offering particular visual comfort thanks to its recessed light source. Gear is suitable for environments requiring a high IP rating and an adjustable light source. It combines visual comfort and versatility with its wide range of accessories.

Speedway and Subway: new linear lighting concepts





Index

16	Prodotti / <i>Product overview</i>
21	Profilo aziendale / <i>Company profile</i>
37	Informazioni tecniche / <i>Technical info</i>
51	Mains Voltage
95	Magic48
155	Micro48
183	Omnia
207	Incassi / <i>Downlights</i>
241	Sospensioni / <i>Pendants</i>
291	Parete / <i>Wall</i>
301	Strip LED e profili / <i>LED Strips & profiles</i>
311	Appendice / <i>Appendix</i>

Mains Voltage

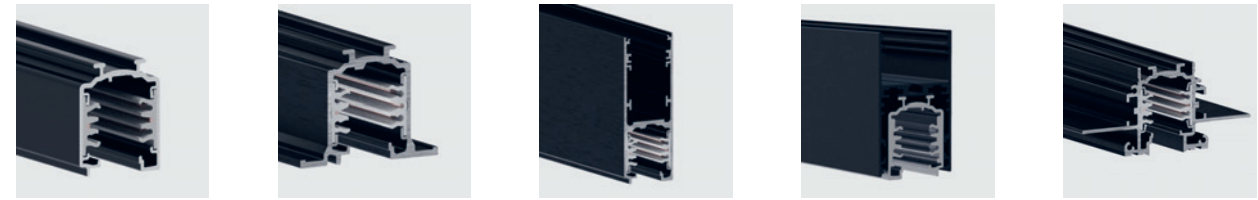

9605 60 9615 61 9625 62 HS Track 63 9620 64



HG Track 65 Otto 68 CTrack 78 Linea Track 86

Magic48



9630 104 9635 105 9655 106 9665 107 9640 108



9645 109 9650 110 Magic Otto 114 Magic Spot 118 Magic K 128



Magic Point & Mini 132 Magic pendant 138 Magic linear 142

Micro48



8630 160 8635 161 8650 162 Micro Otto 164 Micro Point & Mini 168



Micro Ice 172 Micro Linear 176

Omnia



Omnia GA 190 Omnia GB 194 Omnia spot 198 Omnia Lights 202

Incassi / *Downlights*



Sospensioni / *Pendants*



Muro / *Wall*

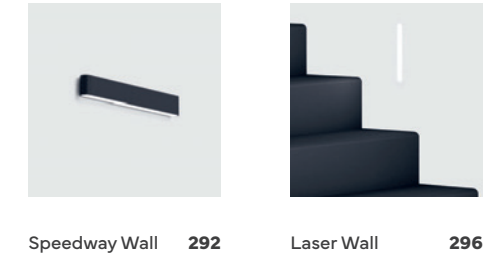

Strips e profili / *Strips & profiles*

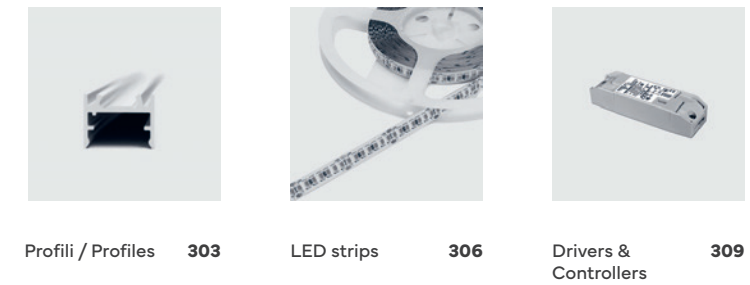

Where light happens

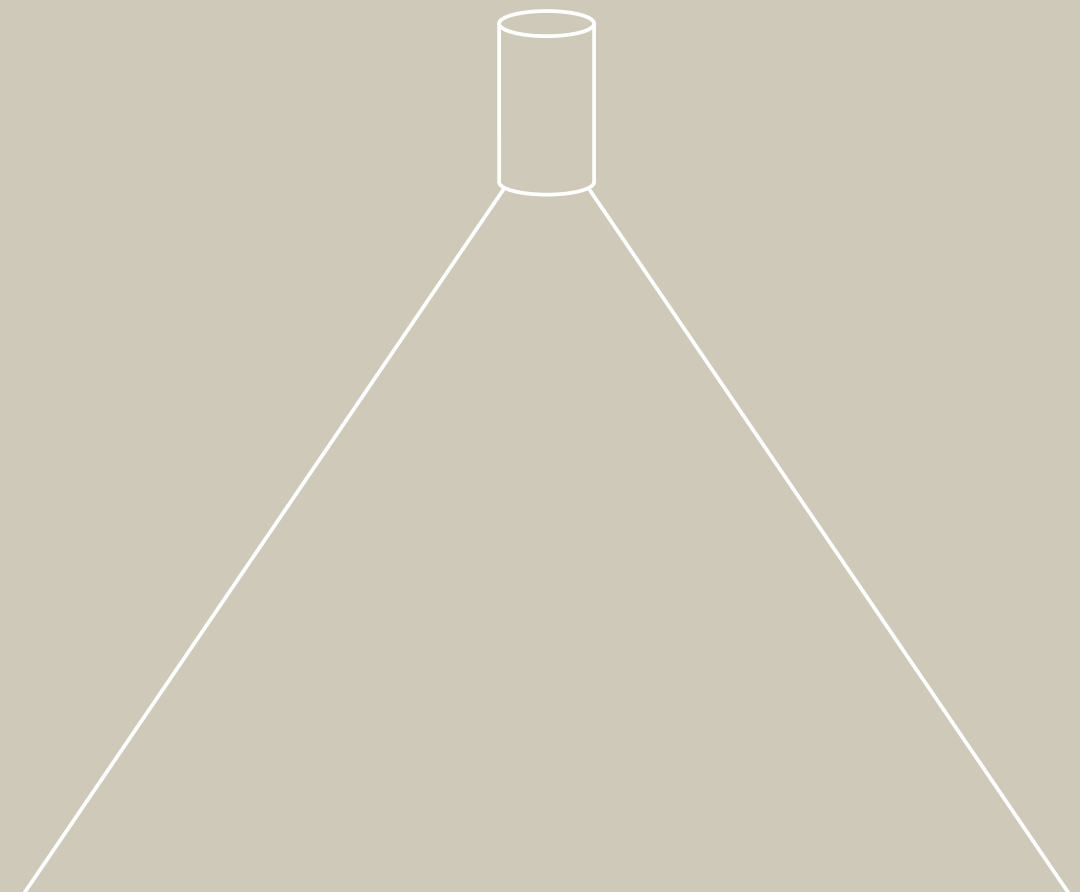

The company

Ilmas nasce nel 1978 e si afferma come partner dinamico e affidabile nel settore dell'illuminazione. La missione aziendale è offrire ai clienti soluzioni tecnologiche avanzate attraverso un approccio aperto e creativo. La costante ricerca di soluzioni innovative guida da sempre l'evoluzione dei prodotti.

Founded in 1978, Ilmas has established itself as a dynamic and reliable partner in the lighting industry. The company's mission is to provide cutting-edge solutions to customers through a creative and open approach. The constant commitment to innovative solutions inspires the evolution of the products.

Grazie a una rete di distribuzione ben organizzata consegniamo i nostri prodotti in Italia e nel mondo. Nei nostri magazzini è presente una gamma diversificata di prodotti che garantisce forniture rapide e affidabili, in linea con le esigenze dei nostri clienti.

Thanks to a well-organized distribution network, we sell our products in Italy and worldwide. A wide range of products is available in our warehouse ensuring fast and reliable delivery to meet our customers' needs.

We are your reliable partner



We are dedicated to customer satisfaction

Ci impegniamo a fornire soluzioni vantaggiose che soddisfino gli standard del mercato, assicurando un giusto equilibrio tra qualità e prezzo. Crediamo inoltre nell'eccellenza del servizio e manteniamo un forte contatto personale con i nostri clienti. La loro soddisfazione è il nostro obiettivo principale.

Our commitment is to provide competitive solutions that meet market standards and ensure a good balance between quality and price. Additionally, we believe in excellent service and in close personal relationships with our customers. Their satisfaction is our priority.



We believe in responsibility

Siamo consapevoli che l'utilizzo di soluzioni ambientali sostenibili è sempre più una necessità del nostro tempo. Per questo ci assumiamo la responsabilità del nostro impatto sul pianeta, selezionando materiali e componenti che possano essere riciclati e riutilizzati.

Il nostro stabilimento produttivo è alimentato da pannelli solari per un totale di 230 KWP. I nostri prodotti utilizzano LED che raggiungono un'efficienza della sorgente fino a 150 lm/w.

We are aware that the use of sustainable environmental solutions is increasingly necessary in our time. Therefore, we take responsibility for our impact on the planet by selecting materials and components that can be recycled and reused.

Our production plant is powered by solar panels with a total power of 230 KWP. Our lighting fixtures use LEDs that achieve a source efficiency up to 150 lm/w.

The group

Nel 2018, Ilmas ha fatto il suo ingresso nel gruppo HB4, holding che comprende 15 aziende e che opera in Italia e all'estero nei settori immobiliare, industriale, automotive e illuminotecnico. La sinergia tra le diverse aziende del gruppo e la loro competenza nei campi elettronico, meccanico, ottico e produttivo hanno consentito a Ilmas di espandere e arricchire il proprio know-how tecnologico, migliorando le prestazioni dei propri prodotti.

In 2018, Ilmas became part of the HB4 Group, a holding that includes 15 companies. HB4 operates in Italy and abroad in the real estate, industrial, automotive and lighting sectors. Ilmas has expanded and enriched its technological expertise by leveraging the synergy between its different companies and their know-how in the electronic, mechanical, optical, and manufacturing fields. This has resulted in improved products performances.

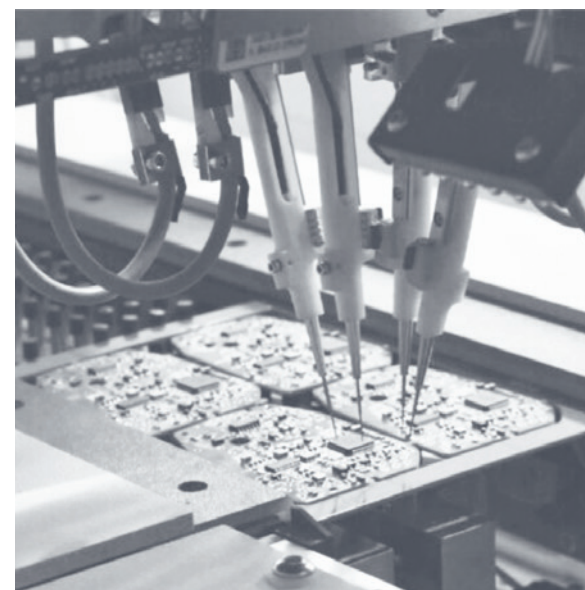

We share our knowledge

Ilmas mette a disposizione dei propri partner il supporto progettuale in ogni sua fase: dalla scelta dei prodotti allo studio illuminotecnico, fino alla fase di installazione e assistenza post vendita.

Ilmas supports its partners throughout the entire project: from product selection to lighting design, from installation phase to after-sales assistance.



Ilmas, grazie al supporto del gruppo HB4, ha avviato un percorso di sviluppo interno dei componenti fondamentali per i suoi prodotti. L'elettronica progettata internamente si distingue per una migliore efficienza energetica e una gestione termica ottimizzata, portando a importanti incrementi nella durata operativa dei prodotti. I riflettori di nuova concezione consentono di migliorare l'efficienza luminosa senza aumentare il consumo energetico.

Thanks to the HB4 Group, Ilmas develops key components for its products in-house. The internally designed electronics are characterised by increased energy efficiency and optimised thermal control, resulting in a significant increase in product lifetime. Newly developed reflectors enable improved luminous efficiency with no increase in energy consumption.





Technical info















Catalogo: guida alla lettura

How to read the catalogue

Marchi e simbologie

Marks and symbols

-  Marchio CE: il prodotto è conforme a tutte le disposizioni europee in vigore che prevedono il suo utilizzo
CE mark: the product complies with all the European provisions in force that provide for its use
-  Apparecchio con grado di abbagliamento luminoso conforme alla normativa DIN EN 12464-1
Glare-free luminaire according to DIN EN 12464-1
-  Il valore RG indica il gruppo di rischio fotobiologico specifico di qualsiasi apparecchio e/o sistema di apparecchio.
The RG value classifies the photobiological risk of any given luminaire and/or luminaire system.
-  Apparecchi incassati non idonei al montaggio in/su superfici normalmente infiammabili quando un materiale termicamente isolante può ricoprire l'apparecchio
Recessed luminaires not suitable for mounting in/on normally flammable surfaces when thermally insulating material may cover the luminaires
-  Temperatura ambiente massima ammessa, alla quale l'apparecchio può essere usato
Maximum allowed ambient temperature at which the luminaire can be used
-  Specifica riferita ad apparecchi da incasso. Dimensioni del foro/apertura da realizzare sulla superficie di installazione.
Specification referred to recessed luminaire. Hole dimensions on installation surface.
-  Isolamento elettrico di Classe 1 / Messa a terra necessaria
Electrical insulation Class 1 / Grounding required
-  Isolamento elettrico Classe 2 / Non richiede la messa a terra in quanto la protezione è data dall'isolamento doppio o rinforzato
Electrical insulation Class 2 / Grounding not required, the protection is given by the double insulation
-  Isolamento elettrico Classe 3 / La protezione contro la folgorazione è data dall'alimentazione a bassissima tensione di sicurezza
Electrical insulation Class 3 / The protection against electrical shock is based on a Safety Extra-Low Voltage power source
-  L'apparecchio deve essere alimentato in tensione di rete (220/240 V - 50/60 Hz)
The appliance must be supplied with mains voltage (220/240 V - 50/60 Hz)
-  L'apparecchio essere alimentato in 24V DC (dovrà essere connesso ad un driver LED dedicato)
The appliance must be supplied with 24V CV (to be connected to a dedicated LED driver)
-  L'apparecchio deve essere alimentato in 48V DC (dovrà essere connesso ad un driver LED dedicato)
The appliance must be supplied with 48V CV (to be connected to a dedicated LED driver)
-  Grado di orientabilità dell'apparecchio
Appliance adjusting angle
-  Grado di rotazione dell'apparecchio
Appliance rotation angle
-  Il valore IP di un apparecchio indica il grado di protezione degli involucri contro l'intrusione di particelle solide e l'accesso di liquidi.
The IP rating indicates the degree to which the housing is protected against the ingress of solid particles and the ingress of liquids.
-  Specifica riferita ad apparecchi da incasso. Il valore IP riportato sopra si riferisce alla parte incassata del prodotto, quello inferiore alla parte visibile.
Specification referred to recessed luminaire. The upper IP rating refers to the recessed part of the item, the lower one refers to the visible part of the lamp.
-  Il grado di protezione meccanica IK misura la resistenza degli involucri contro sollecitazioni meccaniche.
The IK rating refers to the endurance against external mechanical stress.

Main voltage

A C-Track L



D

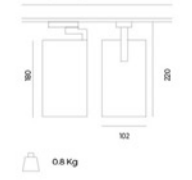

0.8 Kg

□ Bianco opaco
Mat white
■ Nero opaco
Mat black



E

B

Caratteristiche illuminotecniche / Lighting specs						
Watt	Watt LED	mA	IRC/CRI	CCTs	Nom lm	Del lm
34	31	900	>90	3000K 4000K	3767 3909	3719 3253

C

Codice base Base code	Temperatura Temperature	Potenza Power	Fascio Beam	Finitura Finishing	Alimentazione Driver
2342	7 3000K	E 34W	E 20°	1 Bianco White	- On-Off
	8 4000K		N 40° T 60°	2 Nero Black	





220/240V - 50/60Hz

IP20
RG0
CE
Ts 35°C
5 years

H Accessori / Accessories

Basetta di plastica
Plastic base



□ 124200Y1
■ 124200Y2

Basetta da incasso
Recessed base



□ 124200M1
■ 124200M2

Kit luce di emergenza
Emergency light



□ 90008921
■ 90008922

Frangiluce
Honeycomb



C-Track S 2340GR
C-Track M 2340GR
C-Track L 2340GR

Optica
Optical



Options:
20°
40°
60°

2340_20 2340_40 2340_60
2341_20 2341_40 2341_60
2342_20 2342_40 2342_60

ARC46 2024

81

- A** - nome del prodotto

B - codice prodotto (da comporre)

C - specifiche tecniche

D - disegno tecnico

E - finiture disponibili

F - curve fotometriche medie

G - marchi e simbologie

H - accessori
- A - product name*

B - product code (to be composed)

C - technical specifications

D - technical drawing

E - available finishes

F - average photometric curves

G - marks and symbols

H - accessories

LED di qualità per migliori prestazioni

Quality LEDs enhance performance



CRI > 80

CRI > 90

Il costante progresso tecnologico ha reso possibile lo sviluppo di sorgenti luminose con efficienze lm/W sempre maggiori, mantenendo inalterata o migliorando la qualità della luce emessa. Ilmas ha scelto di proporre ai suoi clienti una gamma selezionata di LED che privilegiano la qualità della luce. Tutti i nostri prodotti sono dotati di sorgenti luminose che garantiscono una resa cromatica minima CRI>90, normalmente disponibili nelle temperature colore 2700K, 3000K e 4000K. In aggiunta a queste configurazioni, è possibile personalizzare le forniture con CCT dedicate. Per ottenere le migliori prestazioni, Ilmas propone inoltre LED dotati della tecnologia Sunlike.

Technological progress has made it possible to obtain light sources with increasingly higher efficacy in lm/w, while maintaining or improving the quality of the light emitted. Ilmas offers a selected range of LEDs prioritising light quality. All products are equipped with light sources that guarantee a minimum colour rendering index of CRI>90 and are available in standard CCTs of 2700K, 3000K, and 4000K. In addition to these configurations, the luminaires can be customised with specific colour temperatures. For optimal performance, Ilmas offers LEDs equipped with Sunlike technology.

La tecnologia dei LED COB SunLike, grazie ad una speciale architettura dei suoi diodi, elimina l'emissione di luce blu, esaltando i colori degli oggetti illuminati, con prestazioni paragonabili alla luce solare. Gli spettri dei LED SunLike e della luce solare sono infatti comparabili. Con un CRI di 97.6, i LED SunLike offrono una resa cromatica eccezionale, vicina al valore massimo di 100, indice di riferimento della luce solare. I LED SunLike risultano particolarmente indicati per illuminare ambienti di prestigio come negozi di alta moda, musei, gallerie d'arte e chiese.

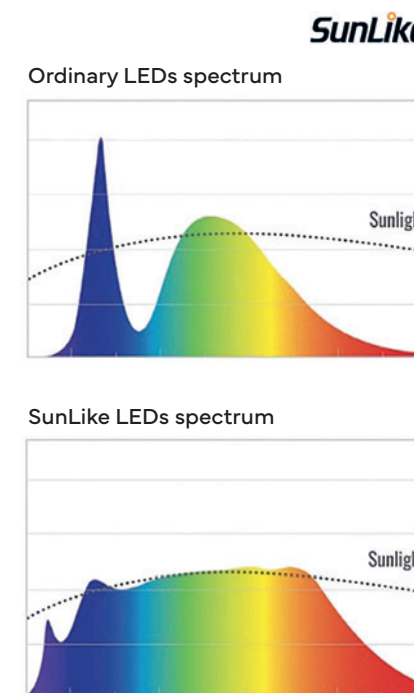

Thanks to a special architecture of each single diodes, the SunLike COB LED technology, eliminates the emission of blue light, enhancing the colours of illuminated objects, achieving solar light performances. The spectra of SunLike LEDs and solar light are comparable. With a CRI value of 97.6, SunLike LEDs offer an outstanding chromatic rendering, close to the maximum value of 100, which represents the sunlight index. SunLike LEDs are particularly suitable for illuminating sophisticated locations such as high-end fashion stores, museums, art galleries and churches.



Conventional LED lighting



SunLike LED lighting

Una gamma di accessori per tutte le applicazioni

A wide range of accessories for any applications



Lenti intercambiabili
Exchangeable lenses



Anello di fissaggio
Locking ring



Frangilucente alveolare
Honeycomb



Stretto
Narrow



Medio
Medium

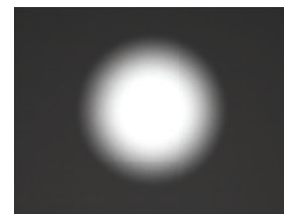

Largo
Wide



Super largo
Super wide



Filtro diffidente
Diffusion filter

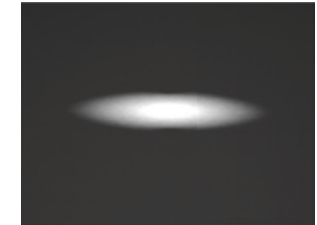

Filtro ellittico
Elliptical filter



Visore a croce
Cross visor



Visore cilindrico
Cylindric visor

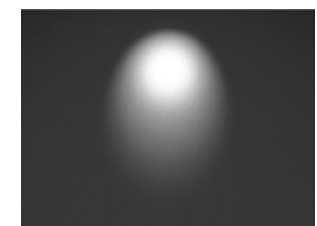

Visore 45°
45° Visor

Sistemi di controllo della luce

Light control systems

Il sistema di controllo tramite pulsante normalmente aperto (PUSH) permette di dimmerare tutti i punti luce connessi al medesimo dispositivo, ma solamente in modalità broadcast, ovvero tutti sincronizzati. Per ottenere questa configurazione è necessario dedicare un cavo aggiuntivo, oltre ai tre cavi di alimentazione (fase, neutro e terra).

Il sistema Push permette di applicare un massimo di 25 carichi per ogni pulsante e non è possibile la creazione di scenari di illuminamento e di gruppo di controllo.

The PUSH control system is a normally open push-button system that enables the control of all lighting points connected to the same device in broadcast mode only. This requires an auxiliary cable in addition to the three standard power cables (phase, neutral and ground).

The push system does not allow the creation of lighting and control group scenarios and limits the number of loads that can be connected to each push-button to 25.

Il protocollo di comando DALI (Digital Adressable Lighting Interface) permette la gestione di tutti i punti luce del sistema in modo indipendente. Per questa configurazione è necessario dedicare due cavi aggiuntivi, solitamente schermati, oltre ai tre cavi di alimentazione (fase, neutro e terra). Il Protocollo DALI permette la creazione di scenari di illuminamento e di gruppo di controllo customizzabili in base alle necessità. Ogni installazione permette la creazione di 16 gruppi di apparecchi e di 16 scenari di intensità ed accensione, con un numero massimo di 64 carichi totali per singolo sistema.

The DALI (Digital Addressable Lighting Interface) control protocol allows all the lighting points in the system to be managed independently. This requires two auxiliary cables, usually shielded, in addition to the three standard power supply cables (phase, neutral and earth).

The DALI protocol allows the creation of lighting and control group scenarios. Each installation allows the creation of 16 groups of luminaires and 16 scenarios, with a maximum of 64 total loads per system.

Il protocollo Casambi funziona tramite Bluetooth, attraverso uno smartphone o un tablet, senza la necessità di altri componenti o di cablaggi aggiuntivi. Casambi permette la creazione di scenari di illuminamento e di gruppi di controllo customizzabili in base alle necessità, con un numero massimo di 127 carichi applicabili ad ogni sistema.

L'ecosistema può essere integrato con sensori e interfacce utente (es. comandi a muro).

È importante sapere che tale sistema non può funzionare senza una connessione internet. Tutte le informazioni ed i settaggi sono infatti registrati nel Cloud.

The Casambi protocol operates via Bluetooth, using a smartphone or tablet, without requiring additional components or wiring. Casambi enables the creation of customisable lighting and control group scenarios, with a maximum of 127 loads applicable to each system.

Sensors and interfaces (e.g. wall switches) can be integrated into the ecosystem. Please note that this system requires an Internet connection, all data are stored in the Cloud.

PUSH dimming

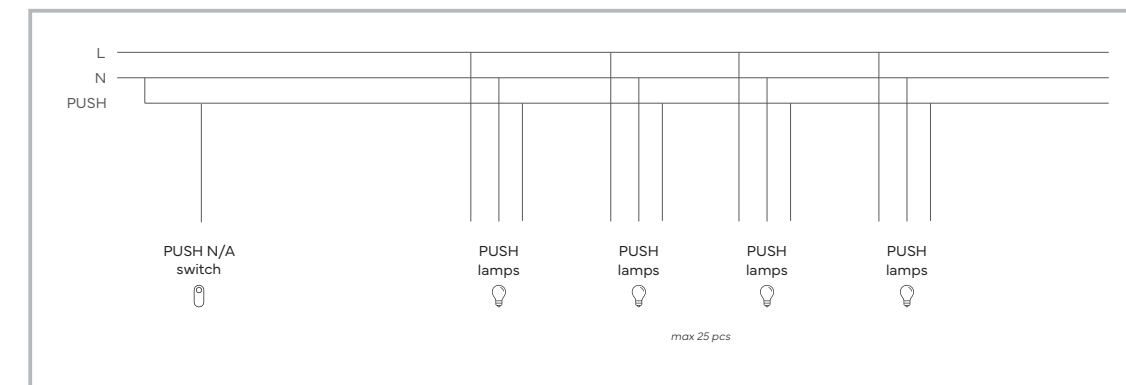

DALI (Digital Adressable Lighting Interface)

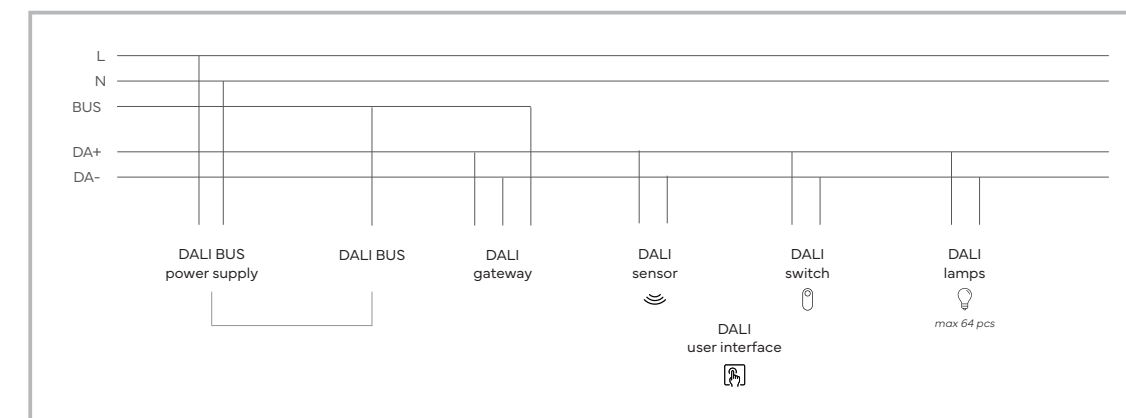

Casambi

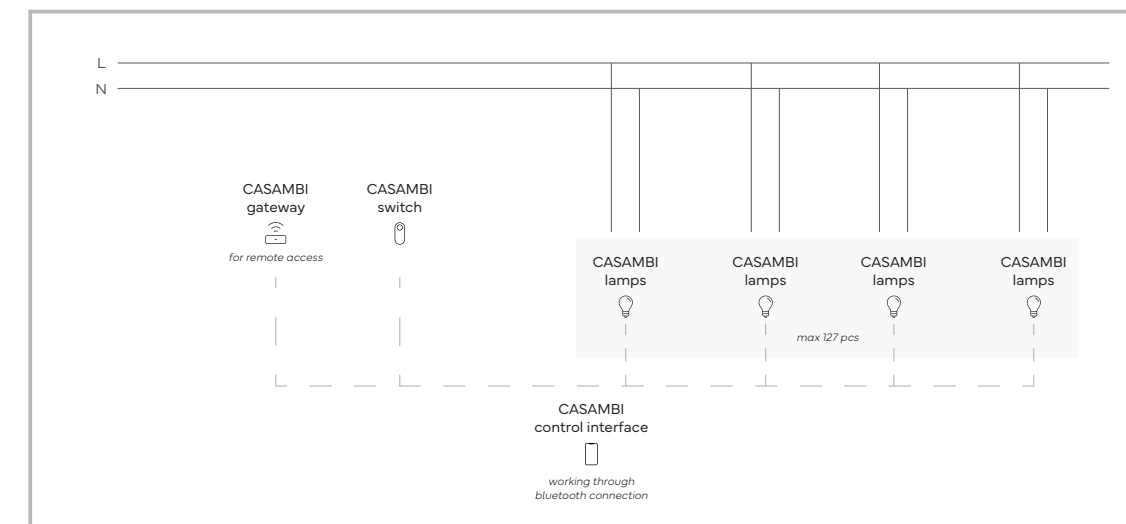

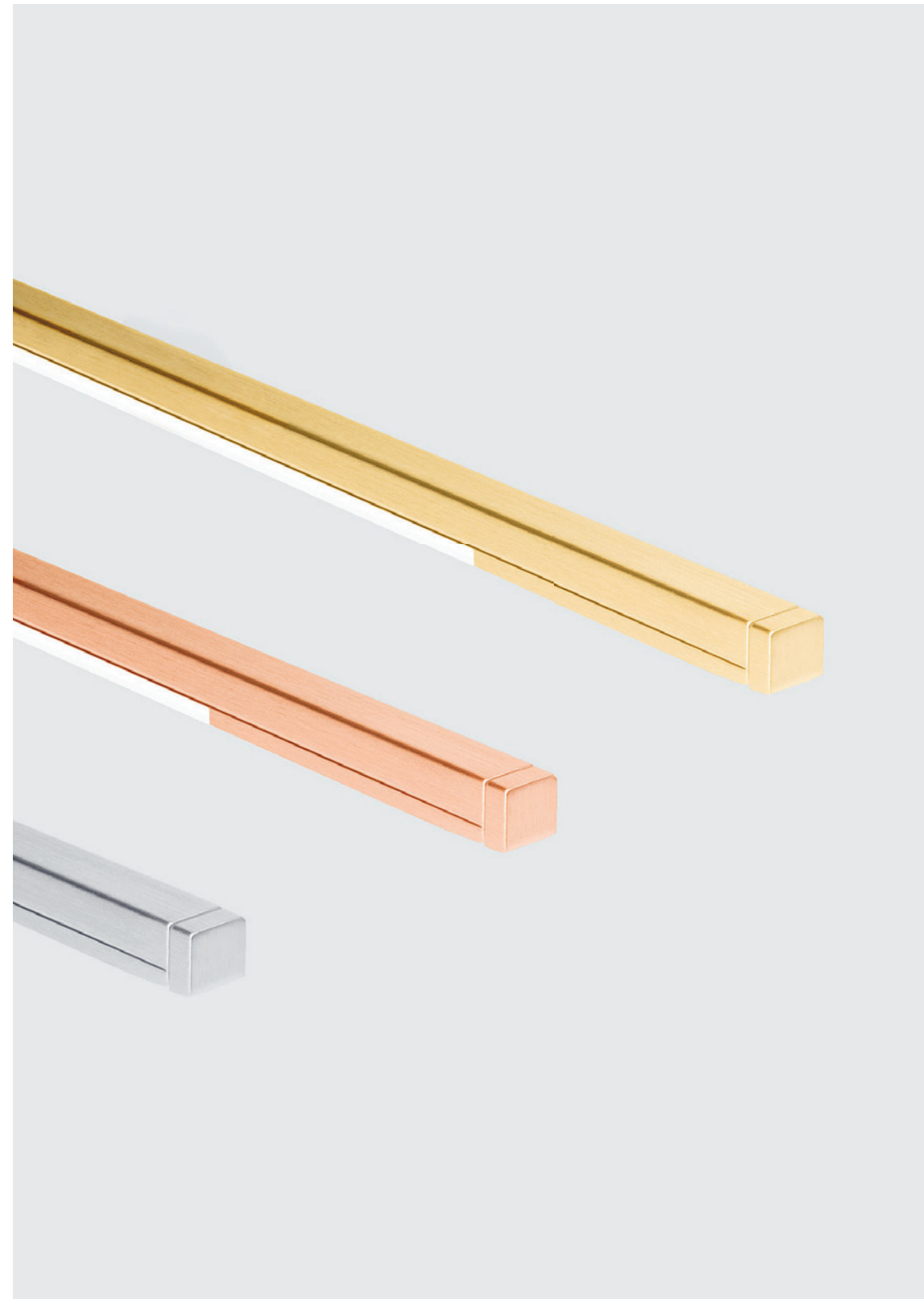

Le finiture

Finishings

Finiture standard / Standard finishings



Bianco raggrinzante (RAL9016)
White wrinkle paint (RAL9016)



Nero raggrinzante (RAL9005)
Black wrinkle paint (RAL9005)

Finiture speciali / Special finishings



Bianco soft-touch
Soft-touch matt white



Nero soft-touch
Soft-touch matt black



Colori RAL e finiture disponibili a richiesta
RAL colours and finishes available on request

Galvaniche spazzolate / Brushed electro-plated



Cromo
Chrome



Oro
Gold



Ottone
Brass

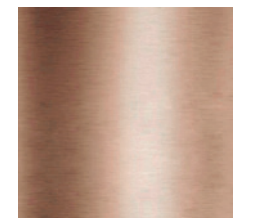

Rame
Copper

Galvaniche lucide / Polished electro-plated



Cromo
Chrome



Oro
Gold



Ottone
Brass

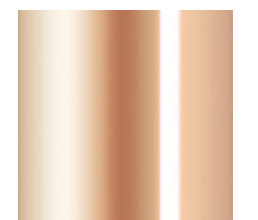

Rame
Copper



Mains voltage

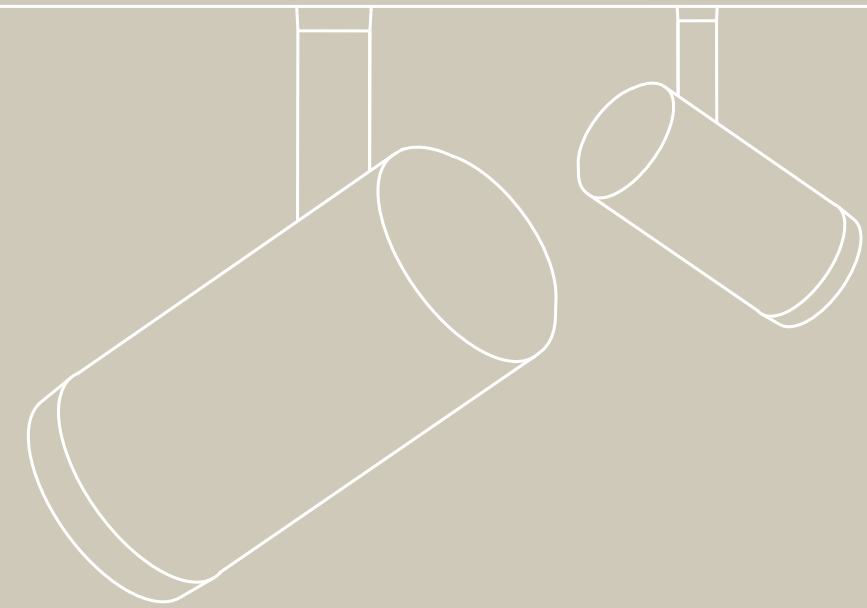

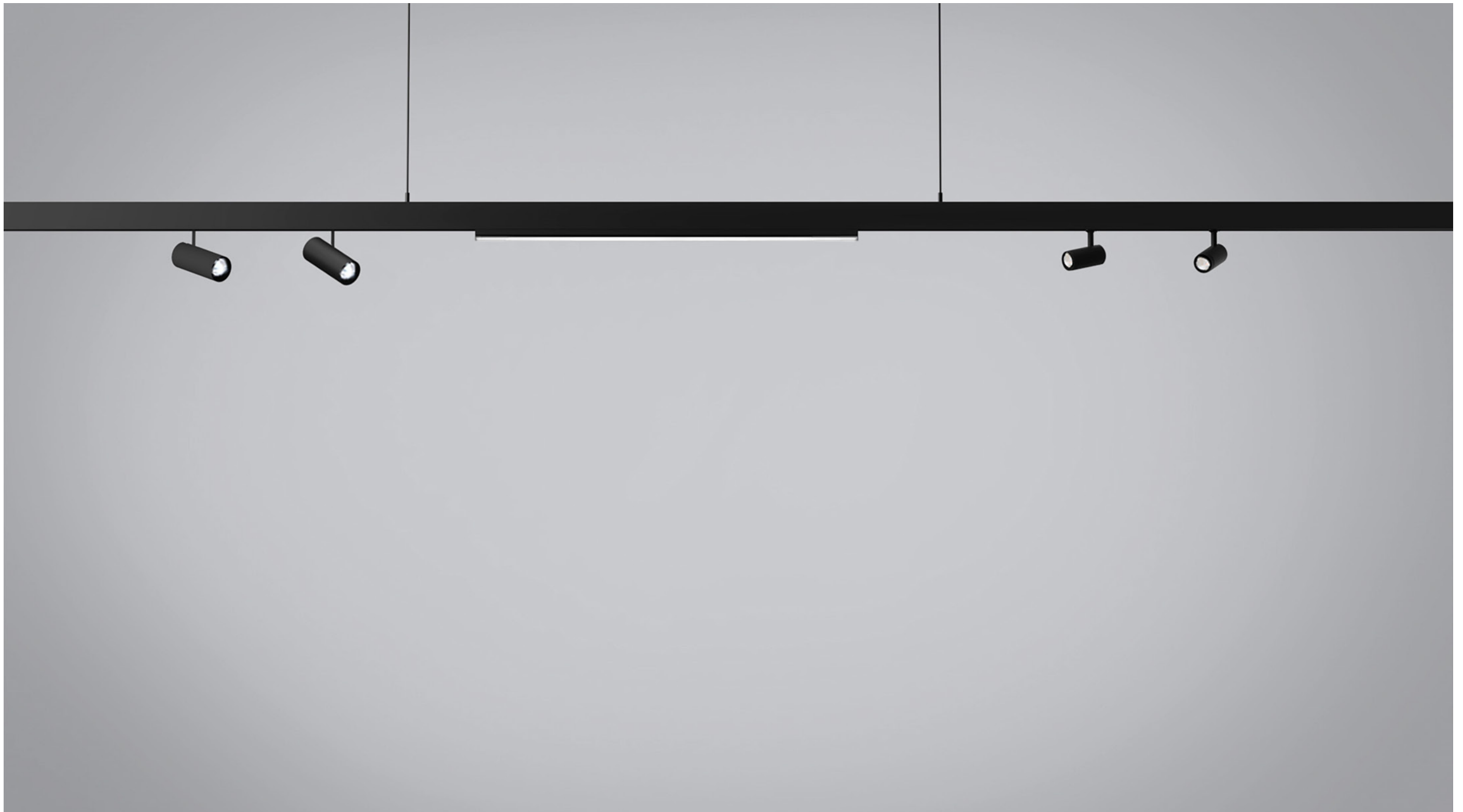

Mains voltage tracks

9605
Standard
Suspended

9625
H track
Suspended

HG track
Recessed
Trimless

9615
Recessed
Trim

9605
Standard
Ceiling

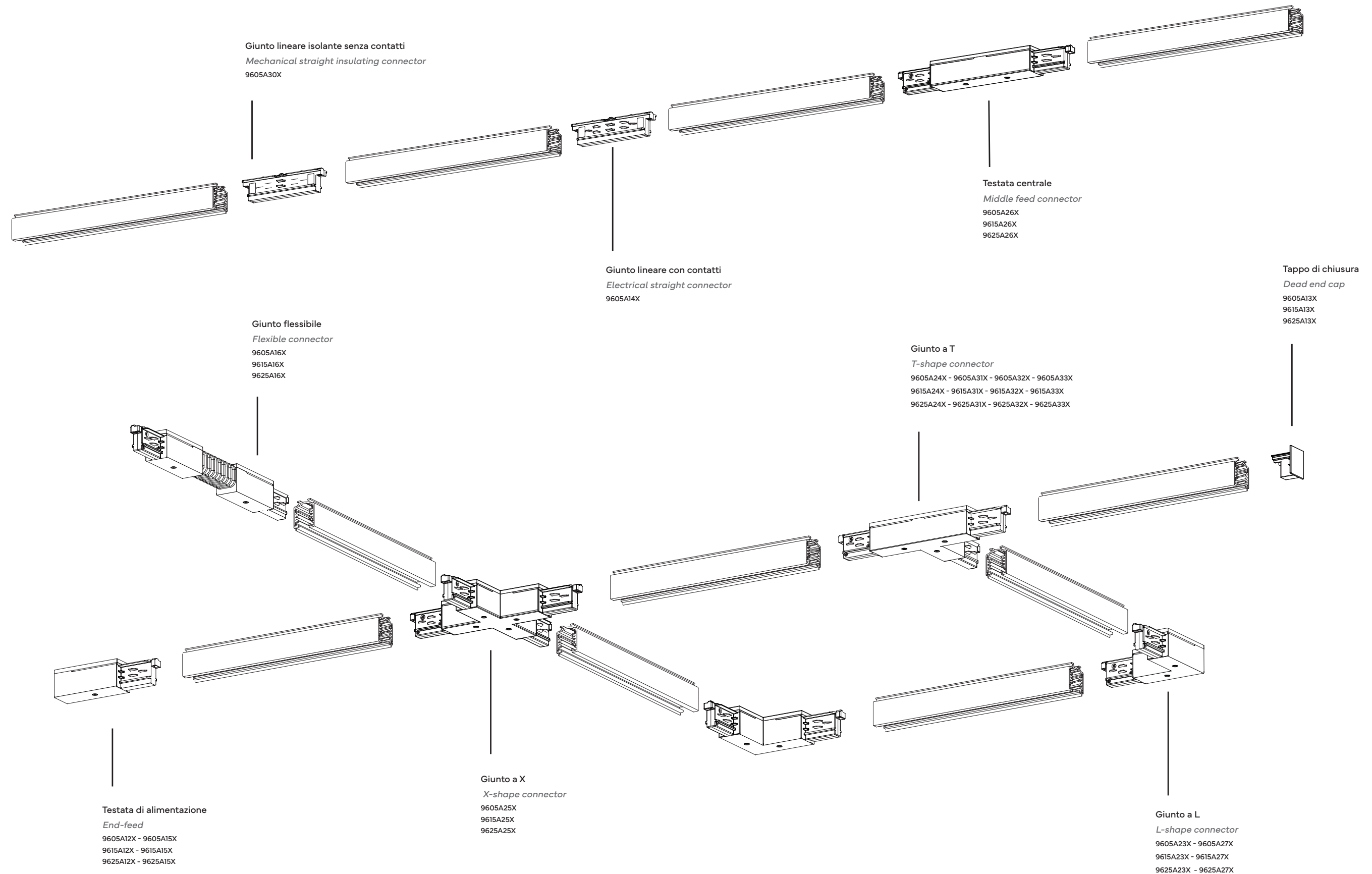

Guida alla configurazione dei binari

Tracks configuration guide

Gli esempi di configurazioni riportati qui sotto sono applicabili a tutti i binari trifase presenti a catalogo e illustrano la corretta installazione di tutti gli accessori di collegamento. Ha fondamentale importanza che la continuità della polarità venga rispettata per tutto il tracciato del binario. Per eventuali dubbi vi invitiamo a contattare l'ufficio tecnico Ilmas.

The examples below are applicable to all three-phase tracks listed on the catalogue and illustrate the correct installation of all connectors. It is important to maintain the polarity continuity throughout the entire track layout. In case of doubts, please contact Ilmas technical office.

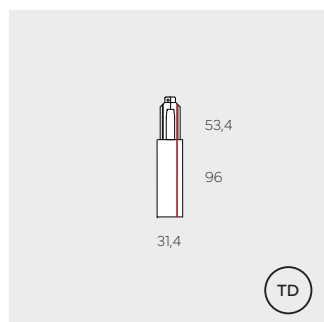

Testata destra
Right end-feed
9605A12X

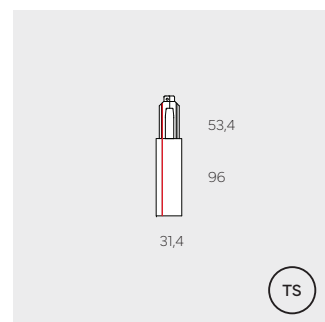

Testata sinistra
Left end-feed
9605A15X

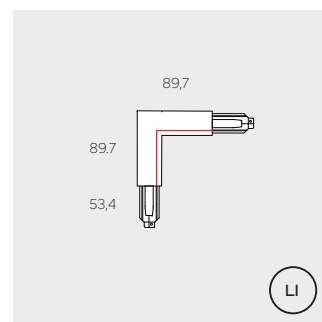

Giunto a L pol. interna
L-connector internal pol.
9605A23X

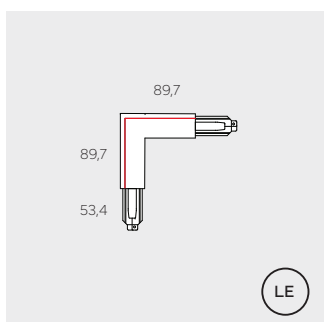

Giunto a L pol. esterna
L-connector external pol.
9605A27X

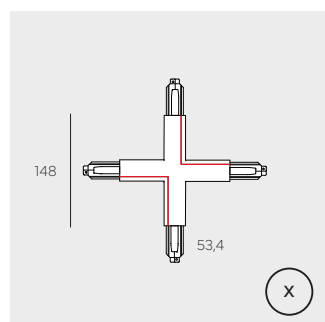

Giunto a X
X-shape connector
9605A25X

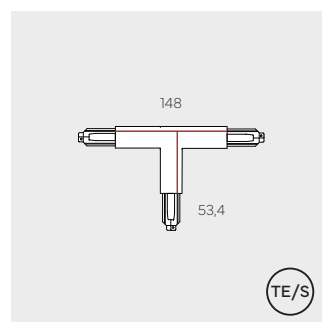

Giunto a T pol. esterna sinistra
T-connector right external pol.
9605A24X

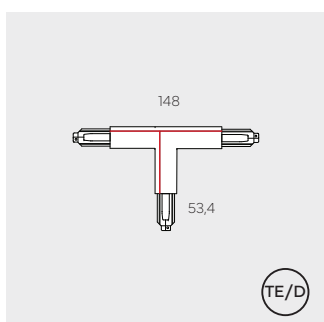

Giunto a T pol. esterna destra
T-connector right external pol.
9605A31X

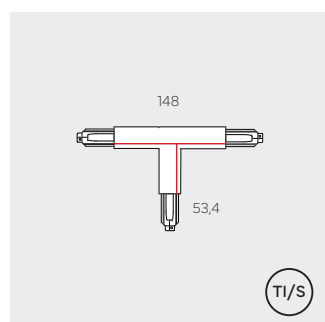

Giunto a T pol. interna sinistra
T-connector left internal pol.
9605A32X

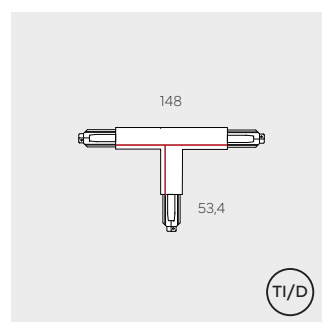

Giunto a T pol. interna destra
T-connector right internal pol.
9605A33X

Esempio di installazione con giunti angolari: a seconda della testata di alimentazione scelta (polarità destra o polarità sinistra), occorre selezionare i giunti angolari con la polarità corretta (interna o esterna).

Installation example with angular connectors: according to the chosen end-feed (right or left polarity), the angular joints must be selected with the correct polarity (internal or external).

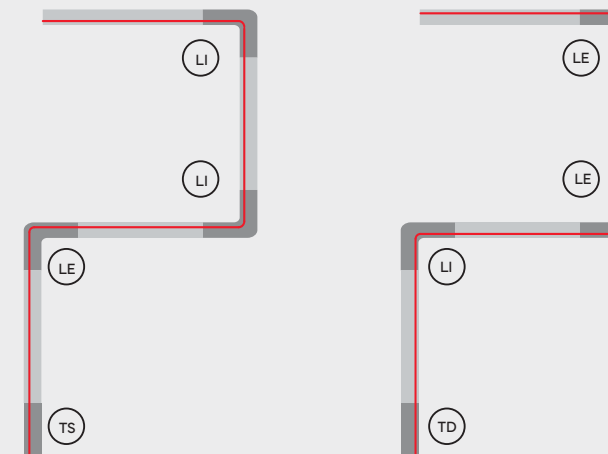

Esempio di installazione con connettore a X: a seconda della testata di alimentazione scelta (polarità destra o polarità sinistra), occorre orientare il connettore a X in modo da rispettare la continuità della polarità lungo tutto il tracciato.

Installation example with X-connector: according to the selected end-feed (right or left polarity), the X-connector must be oriented so that the polarity is maintained throughout the track layout.

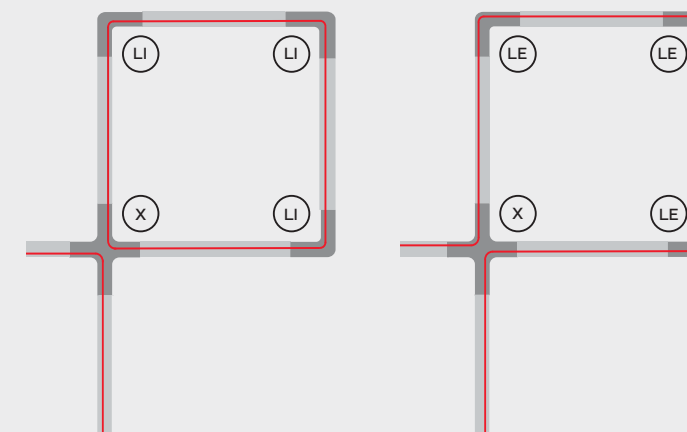

Esempio di installazione con connettore a T. I giunti sono disponibili in 4 versioni: due con polarità esterna (destra e sinistra) e due con polarità interna (destra e sinistra). Selezionare il giunto corretto in modo da rispettare la continuità della polarità.

Installation examples with T-connectors. T-connectors are available in 4 versions: two with external polarity (right and left) and two with internal polarity (right and left). Select the correct connector so as to respect the continuity of polarity.

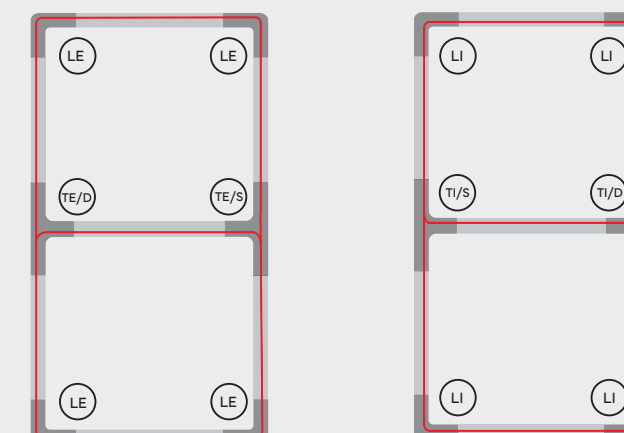

Mains Voltage Standard - 9605

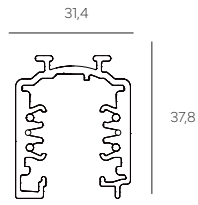
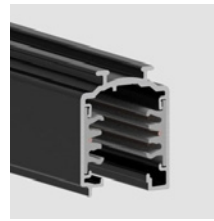

Codice base Base code	Lunghezza mm Length mm	Colore Finishes	Peso Kg Weight Kg
9605	A01 1000	1 Bianco / White	1.05 kg
	A02 2000	2 Nero / Black	2.04 kg
	A03 3000	0 Grigio / Grey	3.06 kg

Binario 3 fasi + DALI in alluminio estruso. Conduttori in rame - tensione di rete 230/250 V - 16A
3 phases + DALI aluminum extruded track. Copper conductors - voltage 230-250V - 16A



Connessioni / Connections

	Testata polarità destra / Right polarity end-feed	9605A121	9605A122		Giunto a L polarità esterna / L-connector external polarity	9605A271	9605A272
	Testata polarità sinistra / Left polarity end-feed	9605A151	9605A152		Giunto a T polarità esterna sinistra / T-connector left external polarity	9605A241	9605A242
	Giunto lineare con contatti / Electrical straight connector	9605A141	9605A142		Giunto a T polarità esterna destra / T-connector right external polarity	9605A311	9605A312
	Giunto lineare isolante senza contatti / Mechanical straight insulating connector	9605A301	9605A302		Giunto a T polarità interna sinistra / T-connector left internal polarity	9605A321	9605A322
	Testata centrale / Middle feed connector	9605A261	9605A262		Giunto a T polarità interna destra / T-connector right internal polarity	9605A331	9605A332
	Giunto flessibile / Flexible connector	9605A161	9605A162		Giunto a X / X-connector	9605A251	9605A252
	Giunto a L polarità interna / L-connector internal polarity	9605A231	9605A232		Pinza per taglio conduttori elettrici / Cutting tool for electric conductors	9605AA997	

Adattatori / Adapters

	Adattatore a 4 conduttori 6A. 5 Kg di carico / 4 conductors adapter 6A. 5 Kg max load	9605A111	9605A112
	Adattatore asimmetrico a 4 conduttori 6A. 5 Kg di carico / Asymmetric 4 conductors adapter 6A. 5 Kg max load	9605A811	9605A812
	Adattatore a 6 conduttori DALI 6A. 5 Kg di carico / Six conductors DALI adapter 6A. 5 Kg max load	9605A721	9605A722
	Adattatore asimmetrico a 6 conduttori DALI 6A. 5 Kg di carico / Asymmetric 6 conductors DALI adapter 6A. 5 Kg max load	9605A821	9605A822
	Adattatore meccanico / Mechanical adapter	9605A171	9605A172

Accessori e sospensioni / Accessories and suspension kits

	Kit sospensione con doppia regolazione / Suspension kit with two grippers	2 m	5 m	9605A627	9605A657
	Kit sospensione a singola regolazione a soffitto / Suspension kit with ceiling gripper	2 m	5 m	9605A727	9605A757
	Tappo di chiusura del binario / Track dead end cap			9605A131	9605A132
	Copertura binario 1000 mm / Track cover 1000 mm			9605A281	9605A282
	Kit per fissaggio a plafone / Ceiling fixing kit			9605A217	

Mains Voltage Recessed - 9615

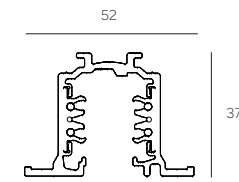
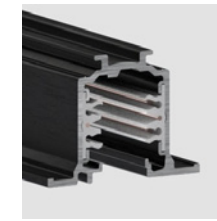

Codice base Base code	Lunghezza mm Length mm	Colore Finishes	Peso Kg Weight Kg
9615	A01 1000	1 Bianco / White	1.20 kg
	A02 2000	2 Nero / Black	2.45 kg
	A03 3000	0 Grigio / Grey	3.60 kg

Binario da incasso 3 fasi + DALI in alluminio estruso. Conduttori in rame - tensione di rete 230/250 V - 16A
Recessed 3 phases + DALI aluminum extruded track. Copper conductors - voltage 230-250V - 16A



Connessioni / Connections

	Testata polarità destra / Right polarity end-feed	9615A121	9615A122		Giunto a L polarità esterna / L-connector external polarity	9615A271	9615A272
	Testata polarità sinistra / Left polarity end-feed	9615A151	9615A152		Giunto a T polarità esterna sinistra / T-connector left external polarity	9615A241	9615A242
	Giunto lineare con contatti / Electrical straight connector	9605A141	9605A142		Giunto a T polarità esterna destra / T-connector right external polarity	9615A311	9615A312
	Giunto lineare isolante senza contatti / Mechanical straight insulating connector	9605A301	9605A302		Giunto a T polarità interna sinistra / T-connector left internal polarity	9615A321	9615A322
	Testata centrale / Middle feed connector	9615A261	9615A262		Giunto a T polarità interna destra / T-connector right internal polarity	9615A331	9615A332
	Giunto a L polarità interna / L-connector internal polarity	9615A231	9615A232		Giunto a X / X-connector	9615A251	9615A252

Adattatori / Adapters

	Adattatore a 4 conduttori 6A. 5 Kg di carico / 4 conductors adapter 6A. 5 Kg max load	9605A111	9605A112
	Adattatore asimmetrico a 4 conduttori 6A. 5 Kg di carico / Asymmetric 4 conductors adapter 6A. 5 Kg max load	9605A811	9605A812
	Adattatore a 6 conduttori DALI 6A. 5 Kg di carico / Six conductors DALI adapter 6A. 5 Kg max load	9605A721	9605A722
	Adattatore asimmetrico a 6 conduttori DALI 6A. 5 Kg di carico / Asymmetric 6 conductors DALI adapter 6A. 5 Kg max load	9605A821	9605A822
	Adattatore meccanico / Mechanical adapter	9605A171	9605A172

Accessori e sospensioni / Accessories and suspension kits

	Kit sospensione di regolazione e staffa / Suspension kit with gripper and bracket	2 m	5 m	9605A627	9605A657
	Tappo di chiusura del binario / Track dead end cap			9615A131	9615A132
	Copertura binario 1000 mm / Track cover 1000 mm			9605A281	9605A282
	Staffa di fissaggio per cartongesso già posato / Fixing bracket for pre-installed plasterboard			9615A217	
	Pinza per taglio conduttori elettrici / Cutting tool for electric conductors			9605AA997	

Mains Voltage H Track - 9625

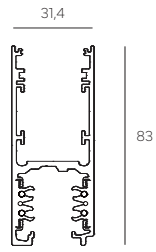

Codice base Base code	Lunghezza mm Length mm	Colore Finishes	Peso Kg Weight Kg
9625	A01 1000	1 Bianco / White	1,75 kg
	A02 2000	2 Nero / Black	3,45 kg
	A03 3000	0 Grigio / Grey	5,25 kg

Binario 3 fasi + DALI i per installazione a sospensione, con possibilità di luce indiretta. Conduttori in rame - 230/250V - 16A
3 phases + DALI track for suspended installation. Indirect light available. Copper conductors - 230-250V - 16A



Mains Voltage Suspended - HS track

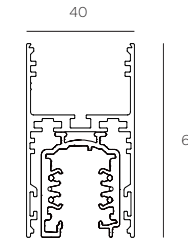

Codice base Base code	Lunghezza mm Length mm	Colore Finishes	Peso Kg Weight Kg
HSTR	A01 1000	1 Bianco / White	2,05 kg
	A02 2000	2 Nero / Black	3,04 kg
	A03 3000	XX RAL code	4,06 kg

Binario 3 fasi + DALI a sospensione, con possibilità di luce indiretta e finitura custom. Conduttori in rame - 230/250V - 16A
3 phases + DALI track for suspended. Indirect light and custom finishings available. Copper conductors - 230-250V



Conessioni / Connections

	Testata polarità destra / Right polarity end-feed	<input type="checkbox"/>	<input checked="" type="checkbox"/>	9625A121	9625A122		Giunto a L polarità esterna / L-connector external polarity	<input type="checkbox"/>	<input checked="" type="checkbox"/>	9625A271	9625A272
	Testata polarità sinistra / Left polarity end-feed	<input type="checkbox"/>	<input checked="" type="checkbox"/>	9625A151	9625A152		Giunto a T polarità esterna sinistra / T-connector left external polarity	<input type="checkbox"/>	<input checked="" type="checkbox"/>	9625A241	9625A242
	Giunto lineare con contatti / Electrical straight connector	<input type="checkbox"/>	<input checked="" type="checkbox"/>	9605A141	9605A142		Giunto a T polarità esterna destra / T-connector right external polarity	<input type="checkbox"/>	<input checked="" type="checkbox"/>	9625A311	9625A312
	Giunto lineare isolante senza contatti / Mechanical straight insulating connector	<input type="checkbox"/>	<input checked="" type="checkbox"/>	9605A301	9605A302		Giunto a T polarità interna sinistra / T-connector left internal polarity	<input type="checkbox"/>	<input checked="" type="checkbox"/>	9625A321	9625A322
	Testata centrale / Middle feed connector	<input type="checkbox"/>	<input checked="" type="checkbox"/>	9625A261	9625A262		Giunto a T polarità interna destra / T-connector right internal polarity	<input type="checkbox"/>	<input checked="" type="checkbox"/>	9625A331	9625A332
	Giunto a L polarità interna / L-connector internal polarity	<input type="checkbox"/>	<input checked="" type="checkbox"/>	9625A231	9625A232		Giunto a X / X-connector	<input type="checkbox"/>	<input checked="" type="checkbox"/>	9625A251	9625A252

Adattatori / Adapters

	Adattatore a 4 conduttori 6A. 5 Kg di carico / 4 conductors adapter 6A. 5 Kg max load	<input type="checkbox"/>	<input checked="" type="checkbox"/>	9605A111	9605A112
	Adattatore asimmetrico a 4 conduttori 6A. 5 Kg di carico / Asymmetric 4 conductors adapter 6A. 5 Kg max load	<input type="checkbox"/>	<input checked="" type="checkbox"/>	9605A811	9605A812
	Adattatore a 6 conduttori DALI 6A. 5 Kg di carico / Six conductors DALI adapter 6A. 5 Kg max load	<input type="checkbox"/>	<input checked="" type="checkbox"/>	9605A721	9605A722
	Adattatore asimmetrico a 6 conduttori DALI 6A. 5 Kg di carico / Asymmetric 6 conductors DALI adapter 6A. 5 Kg max load	<input type="checkbox"/>	<input checked="" type="checkbox"/>	9605A821	9605A822
	Adattatore meccanico / Mechanical adapter	<input type="checkbox"/>	<input checked="" type="checkbox"/>	9605A171	9605A172

Accessori e sospensioni / Accessories and suspension kits

	Kit sospensione di regolazione e staffa / Suspension kit with gripper and bracket	<input type="checkbox"/>	<input checked="" type="checkbox"/>	2 m	5 m	9625A627	9625A657
	Tappo di chiusura del binario / Track dead end cap	<input type="checkbox"/>	<input checked="" type="checkbox"/>	9625A131	9625A132		
	Copertura binario 1000 mm / Track cover 1000 mm	<input type="checkbox"/>	<input checked="" type="checkbox"/>	9605A281	9605A282		
	Pinza per taglio conduttori elettrici / Cutting tool for electric conductors	<input type="checkbox"/>	<input checked="" type="checkbox"/>	9605AA997			

Conessioni / Connections

	Testata polarità destra / Right polarity end-feed	<input type="checkbox"/>	<input checked="" type="checkbox"/>	HSTRA121	HSTRA122		Giunto a L polarità esterna / L-connector external polarity	<input type="checkbox"/>	<input checked="" type="checkbox"/>	HSTRA271	HSTRA272
	Testata polarità sinistra / Left polarity end-feed	<input type="checkbox"/>	<input checked="" type="checkbox"/>	HSTRA151	HSTRA152		Giunto a T polarità esterna sinistra / T-connector left external polarity	<input type="checkbox"/>	<input checked="" type="checkbox"/>	HSTRA241	HSTRA242
	Giunto lineare con contatti / Electrical straight connector	<input type="checkbox"/>	<input checked="" type="checkbox"/>	9605A141	9605A142		Giunto a T polarità esterna destra / T-connector right external polarity	<input type="checkbox"/>	<input checked="" type="checkbox"/>	HSTRA311	HSTRA312
	Giunto lineare isolante senza contatti / Mechanical straight insulating connector	<input type="checkbox"/>	<input checked="" type="checkbox"/>	9605A301	9605A302		Giunto a T polarità interna sinistra / T-connector left internal polarity	<input type="checkbox"/>	<input checked="" type="checkbox"/>	HSTRA321	HSTRA322
	Testata centrale / Middle feed connector	<input type="checkbox"/>	<input checked="" type="checkbox"/>	HSTRA261	HSTRA262		Giunto a T polarità interna destra / T-connector right internal polarity	<input type="checkbox"/>	<input checked="" type="checkbox"/>	HSTRA331	HSTRA332
	Giunto a L polarità interna / L-connector internal polarity	<input type="checkbox"/>	<input checked="" type="checkbox"/>	HSTRA231	HSTRA232		Giunto a X / X-connector	<input type="checkbox"/>	<input checked="" type="checkbox"/>	HSTRA251	HSTRA252

Adattatori / Adapters

	Adattatore a 4 conduttori 6A. 5 Kg di carico / 4 conductors adapter 6A. 5 Kg max load	<input type="checkbox"/>	<input checked="" type="checkbox"/>	9605A111	9605A112
	Adattatore asimmetrico a 4 conduttori 6A. 5 Kg di carico / Asymmetric 4 conductors adapter 6A. 5 Kg max load	<input type="checkbox"/>	<input checked="" type="checkbox"/>	9605A811	9605A812
	Adattatore a 6 conduttori DALI 6A. 5 Kg di carico / Six conductors DALI adapter 6A. 5 Kg max load	<input type="checkbox"/>	<input checked="" type="checkbox"/>	9605A721	9605A722
	Adattatore asimmetrico a 6 conduttori DALI 6A. 5 Kg di carico / Asymmetric 6 conductors DALI adapter 6A. 5 Kg max load	<input type="checkbox"/>	<input checked="" type="checkbox"/>	9605A821	9605A822
	Adattatore meccanico / Mechanical adapter	<input type="checkbox"/>	<input checked="" type="checkbox"/>	9605A171	9605A172

Accessori e sospensioni / Accessories and suspension kits

	Kit sospensione di regolazione e staffa / Suspension kit with gripper and bracket	<input type="checkbox"/>	<input checked="" type="checkbox"/>	2 m	5 m	HSTRA627	HSTRA657
	Tappo di chiusura del binario / Track dead end cap	<input type="checkbox"/>	<input checked="" type="checkbox"/>	9605A131	9605A132		
	Copertura binario 1000 mm / Track cover 1000 mm	<input type="checkbox"/>	<input checked="" type="checkbox"/>	9605A281	9605A282		
	Tappo per cassaforma HS / End-cap for HS housing	<input type="checkbox"/>	<input checked="" type="checkbox"/>	HSTW	HSTB		
	Pinza per taglio conduttori elettrici / Cutting tool for electric conductors	<input type="checkbox"/>	<input checked="" type="checkbox"/>	9605AA997			

Mains Voltage Trimless - 9620

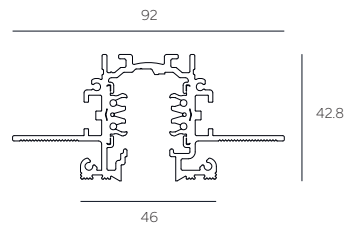
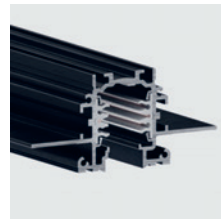

Codice base Base code	Lunghezza mm Length mm	Colore Finishes	Peso Kg Weight Kg
9620	A01 1000	2 Nero / Black	2.20 kg
	A02 2000		3.20 kg
	A03 3000		4.20 kg

Binario 3 fasi + DALI i per installazione a incasso trimless. Conduttori in rame - 230/250V - 16 A
3 phases + DALI track for trimless installation. Copper conductors - 230-250V - 16A



Mains Voltage Trimless - HG Track

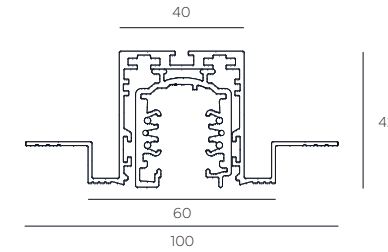
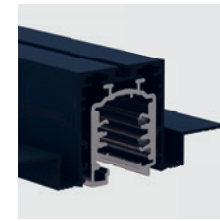

Codice base Base code	Lunghezza mm Length mm	Colore Finishes	Peso Kg Weight Kg
HGTR	A01 1000	1 Bianco / White	2.20 kg
	A02 2000	2 Nero / Black	3.20 kg
	A03 3000		4.20 kg

Binario 3 fasi + DALI i per installazione a incasso trimless. Conduttori in rame - 230/250V - 16 A
3 phases + DALI track for trimless installation. Copper conductors - 230-250V - 16A



Connessioni / Connections

	Testata polarità destra / Right polarity end-feed	9605A122
	Testata polarità sinistra / Left polarity end-feed	9605A152
	Giunto lineare con contatti / Electrical straight connector	9605A142
	Giunto lineare isolante senza contatti / Mechanical straight insulating connector	9605A302
	Giunto a L polarità interna / L-connector internal polarity	9605A232
	Giunto a L polarità esterna / L-connector external polarity	9605A272

Accessori / Accessories

	Tappo di chiusura - lato cieco (da acquistare con 9620A132) / Blind side end cap (to be coupled con 9620A132)	9620A132
	Tappo di chiusura - lato testata / End-feed side end cap	9620A182
	Giunto lineare meccanico / Mechanical linear joint	9650E447
	Controcassa per testata / Recessed housing for end-feed	9620A302
	Controcassa per giunto angolare / Recessed housing for angular joint	9620A262
	Pinza per taglio conduttori elettrici / Cutting tool for electric conductors	9620AA997

Adattatori / Adapters

	Adattatore a 6 conduttori 6A. 5 Kg di carico / 6 conductors adapter 6A. 5 Kg max load	9620A721	9620A722
--	---	----------	----------

Accessori e sospensioni / Accessories and suspension kits

	Kit sospensione di regolazione e staffa / Suspension kit with gripper and bracket	2 m	5 m	9605A627	9605A657
--	---	-----	-----	----------	----------

NB: Il binario è compatibile esclusivamente con i proiettori KXS/I Track, KS/I Track e KL/I Track. Prodotti visionabili sul catalogo IN46 / The 9620 Track is compatible with KXS/I Track, KS/I Track and KL/I Track spotlights only. See products in catalogue IN46.

Connessioni / Connections

	Testata polarità destra / Right polarity end-feed	HGTRA121	HGTRA122
	Testata polarità sinistra / Left polarity end-feed	HGTRA151	HGTRA152
	Giunto lineare con contatti / Electrical straight connector	9605A141	9605A142
	Giunto lineare isolante senza contatti / Mechanical straight insulating connector	9605A301	9605A302
	Testata centrale / Middle feed connector	HGTRA261	HGTRA262
	Giunto a L polarità interna / L-connector internal polarity	HGTRA231	HGTRA232

	Giunto a L polarità esterna / L-connector external polarity	HGTRA271	HGTRA272
	Giunto a T polarità esterna sinistra / T-connector left external polarity	HGTRA241	HGTRA242
	Giunto a T polarità esterna destra / T-connector right external polarity	HGTRA311	HGTRA312
	Giunto a T polarità interna sinistra / T-connector left internal polarity	HGTRA321	HGTRA322
	Giunto a T polarità interna destra / T-connector right internal polarity	HGTRA331	HGTRA332
	Giunto a X / X-connector	HGTRA251	HGTRA252

Adattatori / Adapters

	Adattatore a 4 conduttori 6A. 5 Kg di carico / 4 conductors adapter 6A. 5 Kg max load	9605A111	9605A112
	Adattatore asimmetrico a 4 conduttori 6A. 5 Kg di carico / Asymmetric 4 conductors adapter 6A. 5 Kg max load	9605A811	9605A812
	Adattatore a 6 conduttori DALI 6A. 5 Kg di carico / Six conductors DALI adapter 6A. 5 Kg max load	9605A721	9605A722
	Adattatore asimmetrico a 6 conduttori DALI 6A. 5 Kg di carico / Asymmetric 6 conductors DALI adapter 6A. 5 Kg max load	9605A821	9605A822
	Adattatore meccanico / Mechanical adapter	9605A171	9605A172

Accessori e sospensioni / Accessories and suspension kits

	Tappo di chiusura del binario / Track dead end cap	9605A131	9605A132
	Tappo di chiusura della cassaforma HG / HG end cap	HGTRW	HGTRB
	Copertura binario 1000 mm / Track cover 1000 mm	9605A281	9605A282
	Pinza per taglio conduttori elettrici / Cutting tool for electric conductors	9605AA997	

Binari trifase - avvertenze di installazione

Three-phases tracks - installation notice

Schemi elettrici

Wiring diagrams

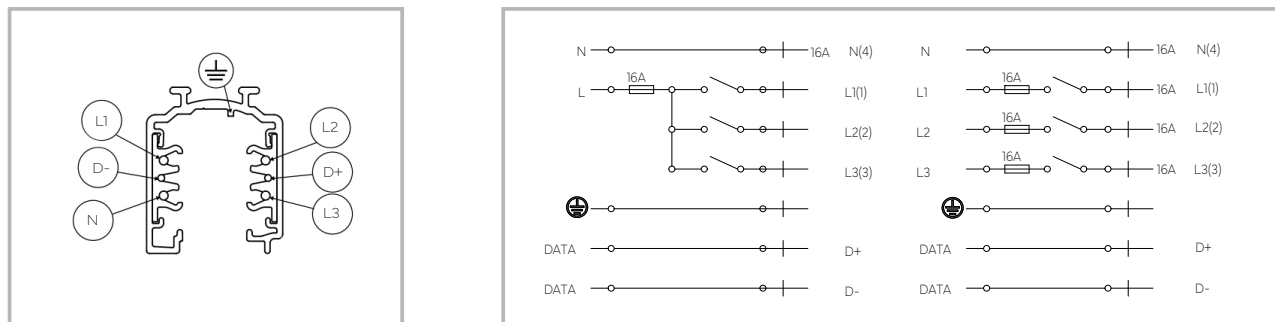

I binari trifase forniti da Ilmas dispongono di due conduttori aggiuntivi per la gestione di un qualsiasi segnale di controllo. L'installazione deve essere eseguita da personale qualificato rispettando gli schemi elettrico indicati. Se si è collegati a una rete elettrica monofase 230V il sistema consente un carico complessivo di 16A, che corrisponde a 3680 Watt ripartibili su tre circuiti (3x1220 Watt). Se si è collegamenti a una rete elettrica trifase 230/400V consente un carico complessivo di 16A, che corrisponde a 11040 Watt suddivisibili su tre circuiti (3x3680 Watt).

Ilmas three-phase tracks have two additional conductors for processing any control signal. Installation must be carried out by qualified personnel in accordance with the wiring diagrams provided. If connected to a 230V single-phase mains supply, the system allows a total load of 16A, which is equivalent to 3680 watts distributed over three circuits (3x1220 watts). If you are connected to a 230/400V three-phase mains supply, the system allow a total load of 16A, which is 11040 watts spread over three circuits (3x3680 watts).

Pinza per taglio conduttori

Cutting tool for track conductors

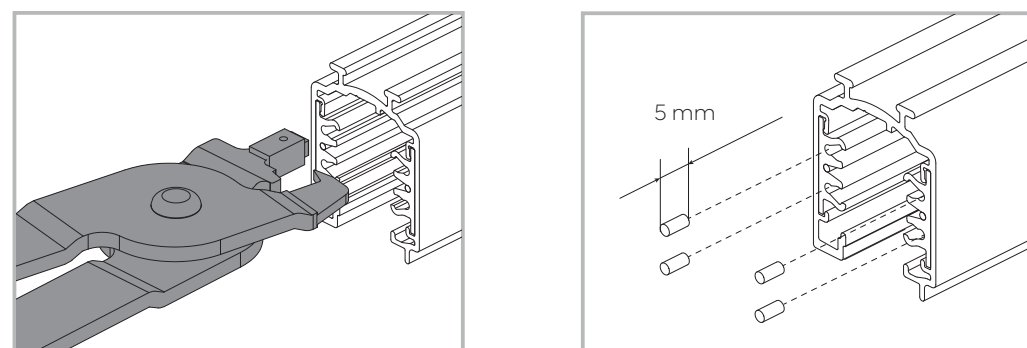

Le barre di binario da 1-2-3 m vengono fornite con i conduttori di rame già incassati come prescritto dalla norma di sicurezza. Nel caso in cui si abbia la necessità di accorciare la lunghezza del binario in fase di installazione, utilizzare la pinza speciale avendo cura di intestare i 4 conduttori (L1-L2-L3-N) di almeno 5 mm.

Track bars of 1-2-3 m are supplied with the copper conductors already recessed in accordance with the relevant safety standard. If it is necessary to shorten the track during installation, use the special cutting tool to recess the four conductors (L1-L2-L3-N) by at least 5mm.

Capacità di carico

Load capacity

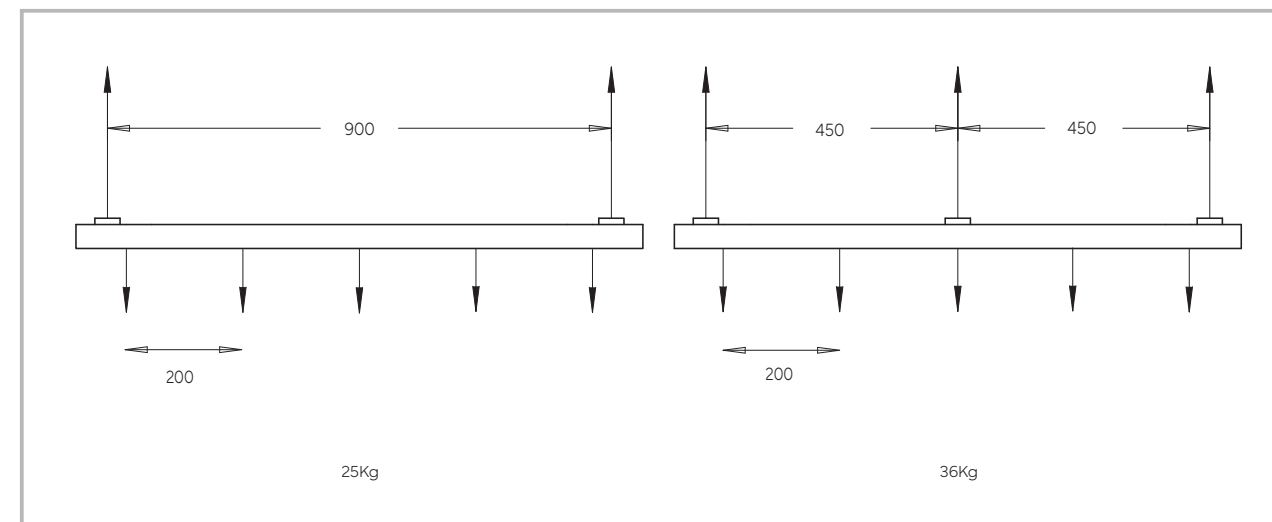

I binari trifase possono sopportare un carico di 25 kg con una distanza massima fra i punti di fissaggio di 900 mm e un carico di 36 kg con una distanza di fissaggio di 450 mm.

The three-phase tracks have a load capacity of 25 kg with a maximum distance of 900 mm among their fixing points and a load of 36 kg with a fixing distance of 450 mm.

Componenti per luce indiretta - solo binario 9625

Indirect light components - 9625 track only

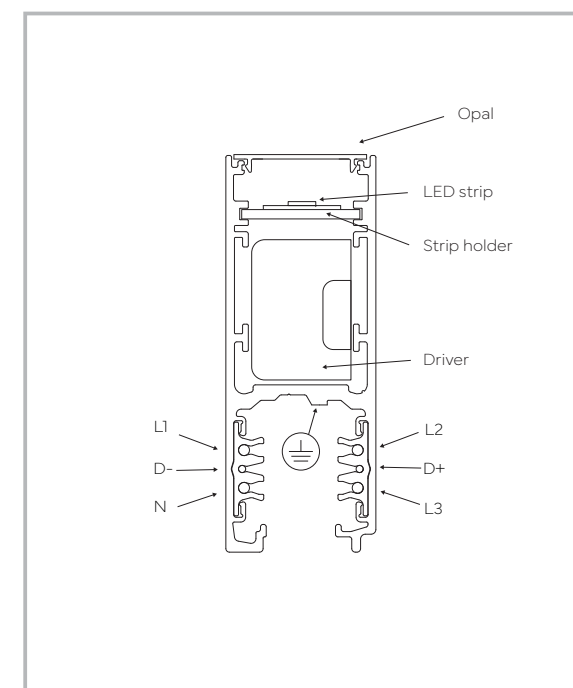

LED strips 24V - 5m

14,4 W/m - 238 LEDs/m - 1300 lm/m

2700K	SV2700
3000K	SV3000
4000K	SV4000

22 W/m - 250 LEDs/m - 2700 lm/m

2700K	SK2700
3000K	SK3000
4000K	SK4000

Supporto strip + Opale

Strip holder + Opal

2 m	9625OPAL2
-----	-----------

Driver 24V

On/Off W

30 W on-off	SNP30-24VF-2
60 W on-off	SL60-24VF



Otto

La serie di proiettori Otto per binario trifase nasce per adattarsi a ogni esigenza di illuminazione. La gamma è composta da tre diverse varianti. Otto 60 con le sue dimensioni compatte offre prestazioni eccellenti. Otto 85 raggiunge quasi 3500lm e dispone di diversi accessori. Otto 105 risulta la scelta ideale per installazioni in ambienti a grandi altezze o dove sono richieste elevate potenze luminose. Tutte le varianti sono personalizzabili.

The Otto series of three-phase track-mounted spotlights includes three different sizes to suit every requirement. Otto 60 offers excellent performances with its compact size. Otto 85 achieves almost 3500 lm with a wide range of accessories. Otto 105 is the ideal choice for installations at great heights or where high light output is required. All mode are customizable.



Sviluppato e prodotto interamente in Italia, Otto è realizzato con materiali di qualità.

Il corpo in alluminio è concepito per ottimizzare la dissipazione del calore, mentre i particolari in policarbonato ad alta resistenza, per offrire prestazioni elevate e funzionalità.

Designed and produced in Italy, Otto is made by high quality components. Its aluminum body is specially designed to optimize heat dissipation. The high-strength PMMA details combine high efficiency with functional design.



Otto 60



Up to 19.5W

Caratteristiche illuminotecniche / Lighting specs

Watt	Watt LED	mA	IRC/CRI	CCTs	Nom lm	Del lm
13.5	12	350	>90	2700K	1521	1217
				3000K	1621	1297
				4000K	1752	1402
19.5	17.5	500	>90	2700K	2069	1653
				3000K	2205	1762
				4000K	2384	1905

Codice base Base code	Temperatura Temperature	Potenza Power	Fascio Beam	Finitura Finishing	Alimentazione Driver
8005	Z 2700K	B 13.5W	C 15°	1 Bianco White	E On-Off
	7 3000K		H 26°		
	8 4000K	L 36°	2 Nero Black	C Casambi	
		T 60°			

* A richiesta è possibile configurare il prodotto con LED speciali e temperature colore dedicate.
Special LEDs and specific colour temperatures can be configured on request.

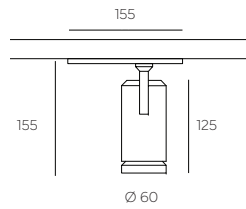
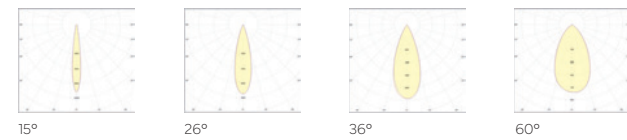

0,4 Kg

Bianco
White

Nero
Black

Finiture custom
Custom finishes

Otto 85



Up to 31 W

Caratteristiche illuminotecniche / Lighting specs

Watt	Watt LED	mA	IRC/CRI	CCTs	Nom lm	Del lm
27	24	700	>90	2700K	3102	2382
				3000K	3306	2539
				4000K	3555	2730
31	27.5	800	>90	2700K	3491	2708
				3000K	3720	2880
				4000K	4000	3081

Codice base Base code	Temperatura Temperature	Potenza Power	Fascio Beam	Finitura Finishing	Alimentazione Driver
8006	Z 2700K	D 27W	O 10°	1 Bianco White	E On-Off
	7 3000K		C 15°		
	8 4000K	H 26°	2 Nero Black	C Casambi	
		L 36°			
	T 60°				

* A richiesta è possibile configurare il prodotto con LED speciali e temperature colore dedicate.
Special LEDs and specific colour temperatures can be configured on request.

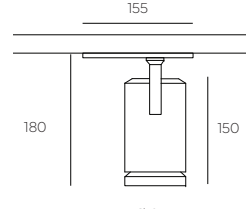
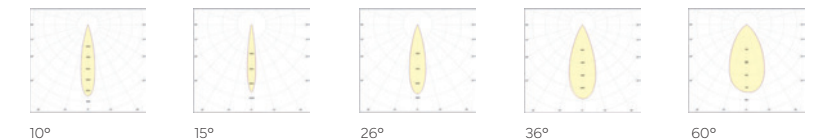

0,8 Kg

Bianco
White

Nero
Black

Finiture custom
Custom finishes

Accessori / Accessories

Kit luce di emergenza
Emergency light



9000B921
9000B922

Frangiluce alveolare
Honeycomb

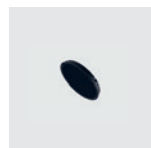

8005GRI

Frangiluce a croce
Cross visor



8005CR

Filtro diffondente
Diffuse filter

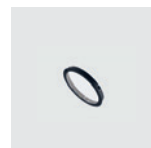

8005DI

Filtro ovale
Oval filter

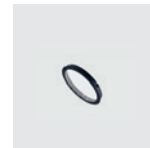

8005OV

Visore cilindrico
Cylindric visor



8005VC

Visore 45°
45° visor



8005VO

Lenti
Lenses

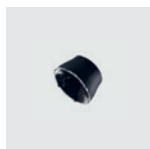

15° 800515
26° 800526
36° 800536
60° 800560

Accessori / Accessories

Kit luce di emergenza
Emergency light



9000B921
9000B922

Frangiluce alveolare
Honeycomb



8006GRI

Frangiluce a croce
Cross-blade visor

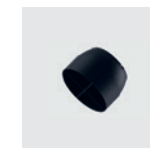

8006CR

Filtro diffondente
Diffuse filter

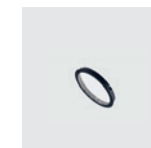

8006DI

Filtro ovale
Oval filter

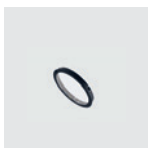

8006OV

Visore cilindrico
Cylindric visor



8006VC

Visore 45°
45° visor



8006DO

Lenti
Lenses

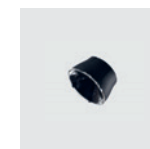

10° 800610
15° 800615
26° 800626
36° 800636
60° 800660

Otto 105



Up to 41 W

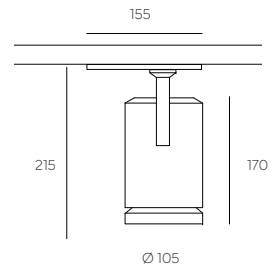

1,2 Kg

Bianco White

Nero Black

Finiture custom Custom finishes

Caratteristiche illuminotecniche / Lighting specs

Watt	Watt LED	mA	IRC/CRI	CCTs	Nom lm	Del lm
35	31	900	>90	2700K	3856	3007
				3000K	4110	3205
				4000K	4419	3447
41	37	1050	>90	2700K	4326	3378
				3000K	4610	3596
				4000K	4958	3867

Codice base Base code	Temperatura Temperature	Potenza Power	Fascio Beam	Finitura Finishing	Alimentazione Driver
8007	Z 2700K	E 35W	B 12°	1 Bianco White	E On-Off
	7 3000K	F 41W	F 24°	2 Nero Black	L DALI
	8 4000K		M 38°	C Casambi	
			T 60°		

* A richiesta è possibile configurare il prodotto con LED speciali e temperature colore dedicate.
Special LEDs and specific colour temperatures can be configured on request.

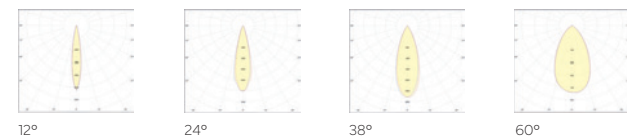

P20
RG1
CE
T_a 25 °C
355°
90°
Optional SunLike
5 years Warranty up to



Accessori / Accessories

Kit luce di emergenza
Emergency light



9000B921
9000B922

Frangiluce alveolare
Honeycomb



8007GRI

Frangiluce a croce
Cross-blade visor



8007 CR

Filtro diffondente
Diffuse filter

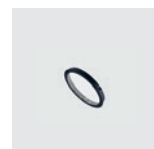

8005DI

Lenti
Lenses

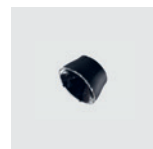

12° 8007I2
24° 800724
38° 800738
60° 800760



C Track

Linea di proiettori per installazione a binario con alimentazione integrata, studiata per applicazioni in ambito retail e hospitality. C Track è disponibile in tre dimensioni, in base alle potenze richieste. C Track, in tutte le sue versioni, è disponibile in tre fasci differenti per permettere di soddisfare le diverse necessità di illuminamento.

La gamma è stata studiata per garantire un'ottima efficienza luminosa e termica, limitando il peso del prodotto.

Track spotlights designed for retail and hospitality applications, with integrated power supply.

C Track is available in three different sizes, according to the power required. All product versions, are available in three different beams in order to meet every luminance requirement.

C Track has been designed to optimize lighting and thermal efficiency while limiting product weight to the fullest.





C Track S



17 W

Caratteristiche illuminotecniche / Lighting specs

Watt	Watt LED	mA	IRC/CRI	CCTs	Nom lm	Del lm
17	14.5	400	>90	3000K 4000K	1637 1778	1347 1463

Codice base Base code	Temperatura Temperature	Potenza Power	Fascio Beam	Finitura Finishing	Alimentazione Driver
2340	7 3000K	4 17W	E 20°	1 Bianco White	- On-Off
	8 4000K		N 40°	2 Nero Black	
			T 60°		

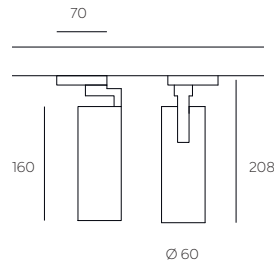

0,5 Kg

□ Bianco
White
■ Nero
Black

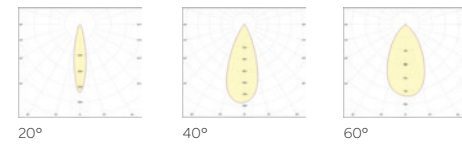

220/240V - 50/60Hz



CTrack L



34 W

Caratteristiche illuminotecniche / Lighting specs

Watt	Watt LED	mA	IRC/CRI	CCTs	Nom lm	Del lm
34	31	900	>90	3000K 4000K	3767 3929	3119 3253

Codice base Base code	Temperatura Temperature	Potenza Power	Fascio Beam	Finitura Finishing	Alimentazione Driver
2342	7 3000K	E 34W	E 20°	1 Bianco White	- On-Off
	8 4000K		N 40°	2 Nero Black	
			T 60°		

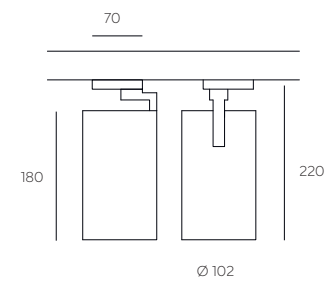

0,8 Kg

□ Bianco
White
■ Nero
Black

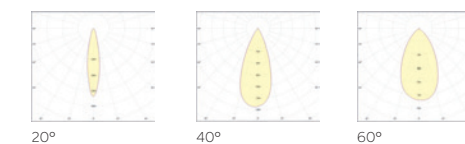

220/240V - 50/60Hz



C Track M



24 W

Caratteristiche illuminotecniche / Lighting specs

Watt	Watt LED	mA	IRC/CRI	CCTs	Nom lm	Del lm
24	215	600	>90	3000K 4000K	2697 2756	2217 2265

Codice base Base code	Temperatura Temperature	Potenza Power	Fascio Beam	Finitura Finishing	Alimentazione Driver
2341	7 3000K	Q 24W	E 20°	1 Bianco White	- On-Off
	8 4000K		N 40°	2 Nero Black	
			T 60°		

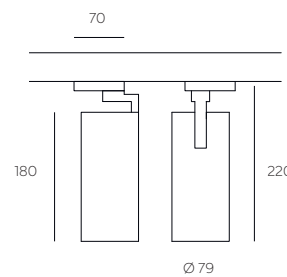

1,0 Kg

□ Bianco
White
■ Nero
Black

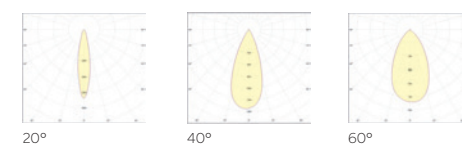

220/240V - 50/60Hz



Accessori / Accessories

Basetta di plastica
Plastic base



□ 124200Y1
■ 124200Y2

Basetta da incasso
Recessed base



□ 124200M1
■ 124200M2

Kit luce di emergenza
Emergency light



□ 9000B921
■ 9000B922

Frangiluce
Honeycomb

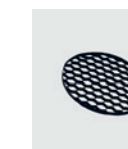

C-Track S 2340GRI
C-Track M 2341GRI
C-Track L 2342GRI

Ottica
Optical

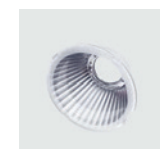

234020 234040 234060
234120 234140 234160
234220 234240 234260

Options:
20°
40°
60°



Linea Track

Linea Track è stato pensato per integrare all'interno dei sistemi a binario trifase dispositivi lineari a basso impatto estetico. Disponibile in tre differenti versioni: Opal, UGR<19 e Spot, Linea Track si presta a diverse applicazioni. Realizzato in estruso di alluminio consente di personalizzare la lunghezza secondo le esigenze dei singoli progetti.

Linea Track is a product that allows the integration of linear devices in three-phase track systems with a low aesthetic impact. It comes in three versions: Opal, UGR<19, and Spot, making it suitable for a wide range of applications. Made of extruded aluminum, it can be customized in length for each specific project.



Lineatrac Opal



Up to 36 W

Caratteristiche illuminotecniche / Lighting specs

Watt	Watt LED	mA	IRC/CRI	CCTs	Nom lm	Del lm
14	10.4	500 mA	>90	3000K 4000K	1700 1810	1040 1108
20	15.6	500 mA	>90	3000K 4000K	2550 2715	1561 1662
25	20.8	500 mA	>90	3000K 4000K	3400 3620	2081 2215
31	26	500 mA	>90	3000K 4000K	4250 4525	2601 2769
36	31.2	500 mA	>90	3000K 4000K	5100 5430	3121 3323

Codice base Base code	Potenza / Lunghezza Power / Length	Temperatura Temperature	Finitura Finishing	Alimentazione Driver
LINEA	0560 10.4 w / 568 mm 0840 15.6 w / 848 mm 1120 20.8 w / 1128 mm 1400 26 w / 1408 mm 1680 31.2 w / 1688 mm	3K 3000K 4K 4000K	1 Bianco White 2 Nero Black	E On/Off L DALI

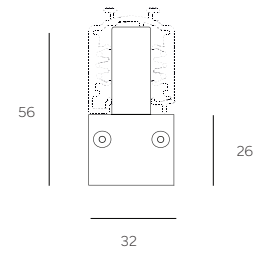

568/848/1128/1408/1688 mm

0,6 - 1,7 Kg

Bianco
White
Nero
Black

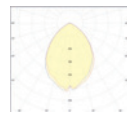

Diffuso



Lineatrac Spot



Up to 25 W

Caratteristiche illuminotecniche / Lighting specs

Watt	Watt LED	mA	IRC/CRI	CCTs	Nom lm	Del lm
14	10.4	500 mA	>90	3000K 4000K	1700 1810	1040 1108
20	15.6	500 mA	>90	3000K 4000K	2550 2715	1561 1662
25	20.8	500 mA	>90	3000K 4000K	3400 3620	2081 2215

Codice base Base code	Potenza / Lunghezza Power / Length	Temperatura Temperature	Fascio Beam	Finitura Finishing	Alimentazione Driver
LINES	0560 11W / 568 mm 0840 16.5W / 848 mm 1120 22W / 1128 mm	3K 3000K 4K 4000K	C 15° K 30° T 60° O 25°x45°	1 Bianco White 2 Nero Black	E On/Off L DALI

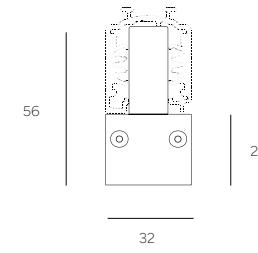

568/848/1128 mm

0,8 - 1,8 Kg

Bianco
White
Nero
Black

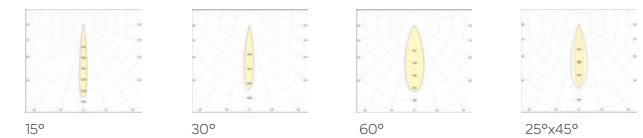

Lineatrac Microprismatic UGR <19



Up to 36 W

Caratteristiche illuminotecniche / Lighting specs

Watt	Watt LED	mA	IRC/CRI	CCTs	Nom lm	Del lm
14	10.4	500 mA	>90	3000K 4000K	1700 1810	1040 1108
20	15.6	500 mA	>90	3000K 4000K	2550 2715	1561 1662
25	20.8	500 mA	>90	3000K 4000K	3400 3620	2081 2215
31	26	500 mA	>90	3000K 4000K	4250 4525	2601 2769
36	31.2	500 mA	>90	3000K 4000K	5100 5430	3121 3323

Codice base Base code	Potenza / Lunghezza Power / Length	Temperatura Temperature	Finitura Finishing	Alimentazione Driver
LINEB	0560 10.4 w / 568 mm 0840 15.6 w / 848 mm 1120 20.8 w / 1128 mm 1400 26 w / 1408 mm 1680 31.2 w / 1688 mm	3K 3000K 4K 4000K	1 Bianco White 2 Nero Black	E On/Off L DALI

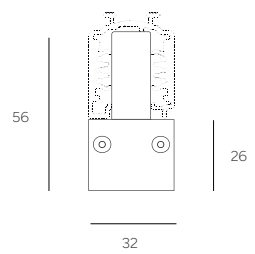

568/848/1128/1408/1688 mm

0,6 - 1,7 Kg

Bianco
White
Nero
Black

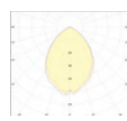

Diffuso





Magic 48

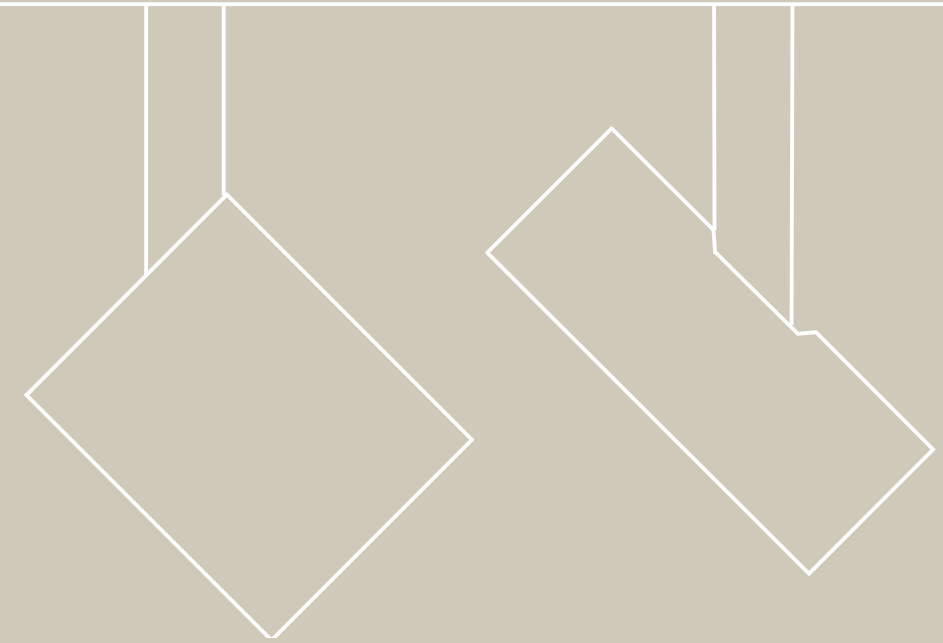

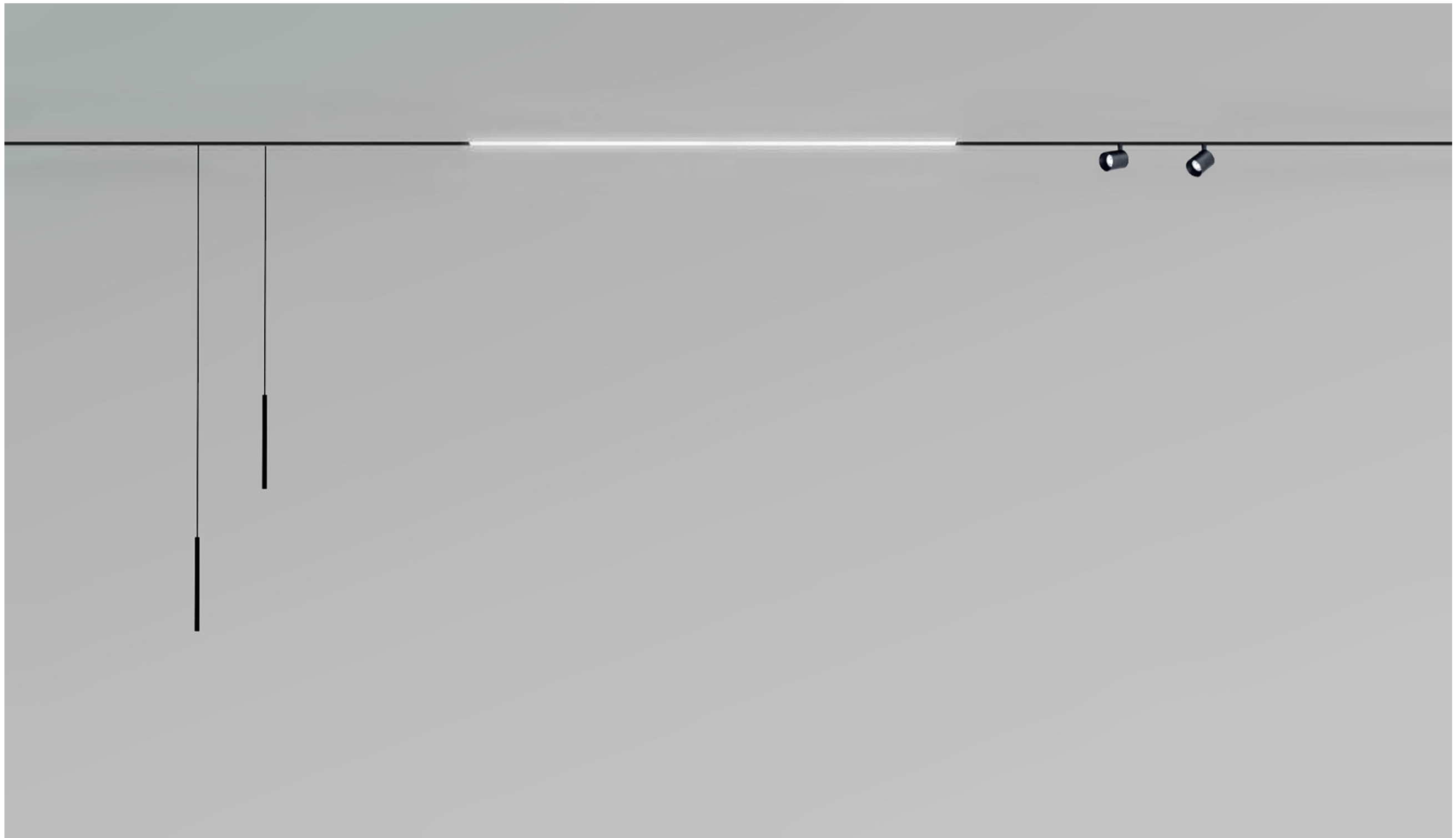

Magic tracks 48V

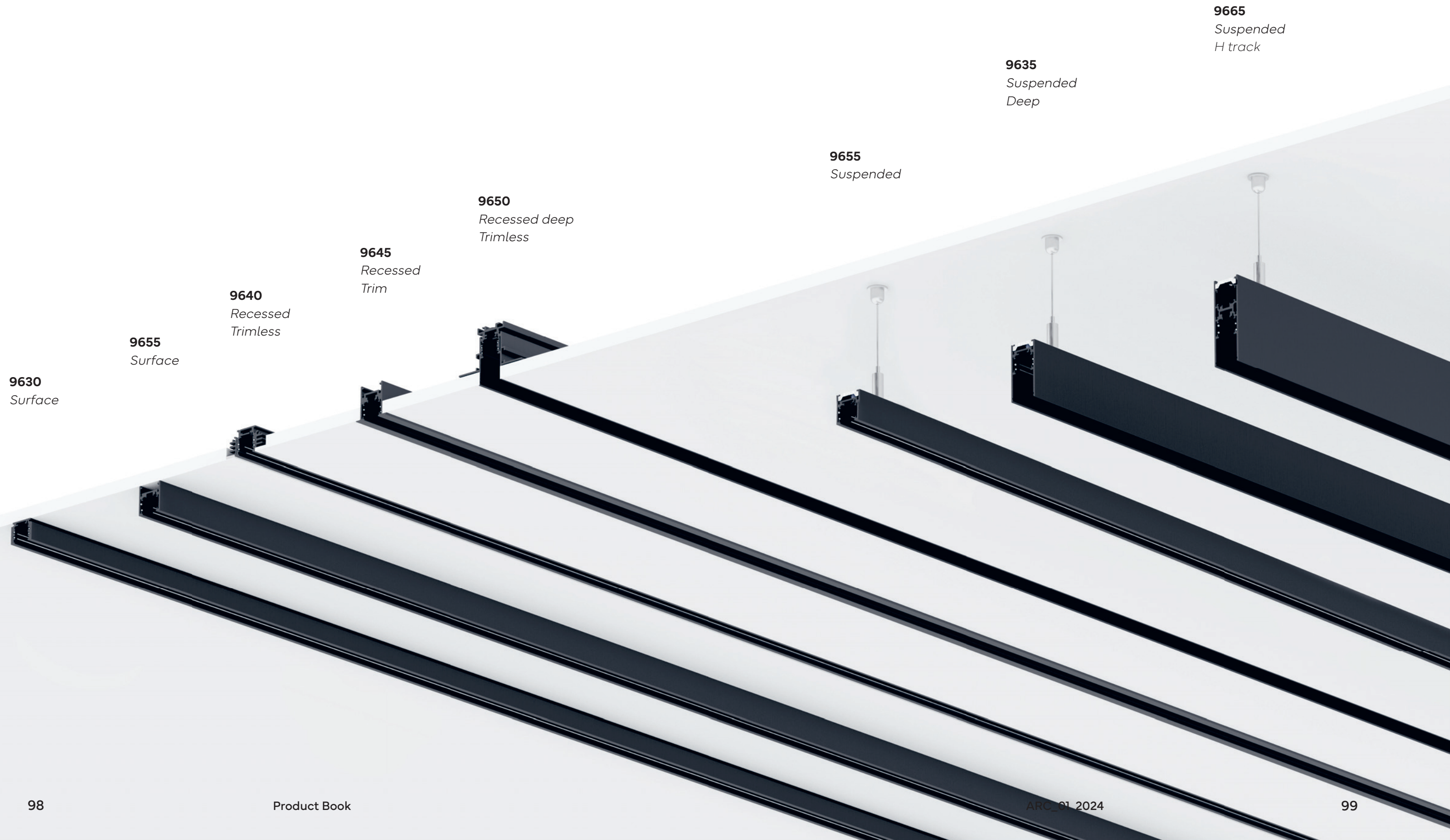

9630
Surface

9655
Surface

9640
Recessed
Trimless

9645
Recessed
Trim

9650
Recessed deep
Trimless

9655
Suspended

9635
Suspended
Deep

9665
Suspended
H track

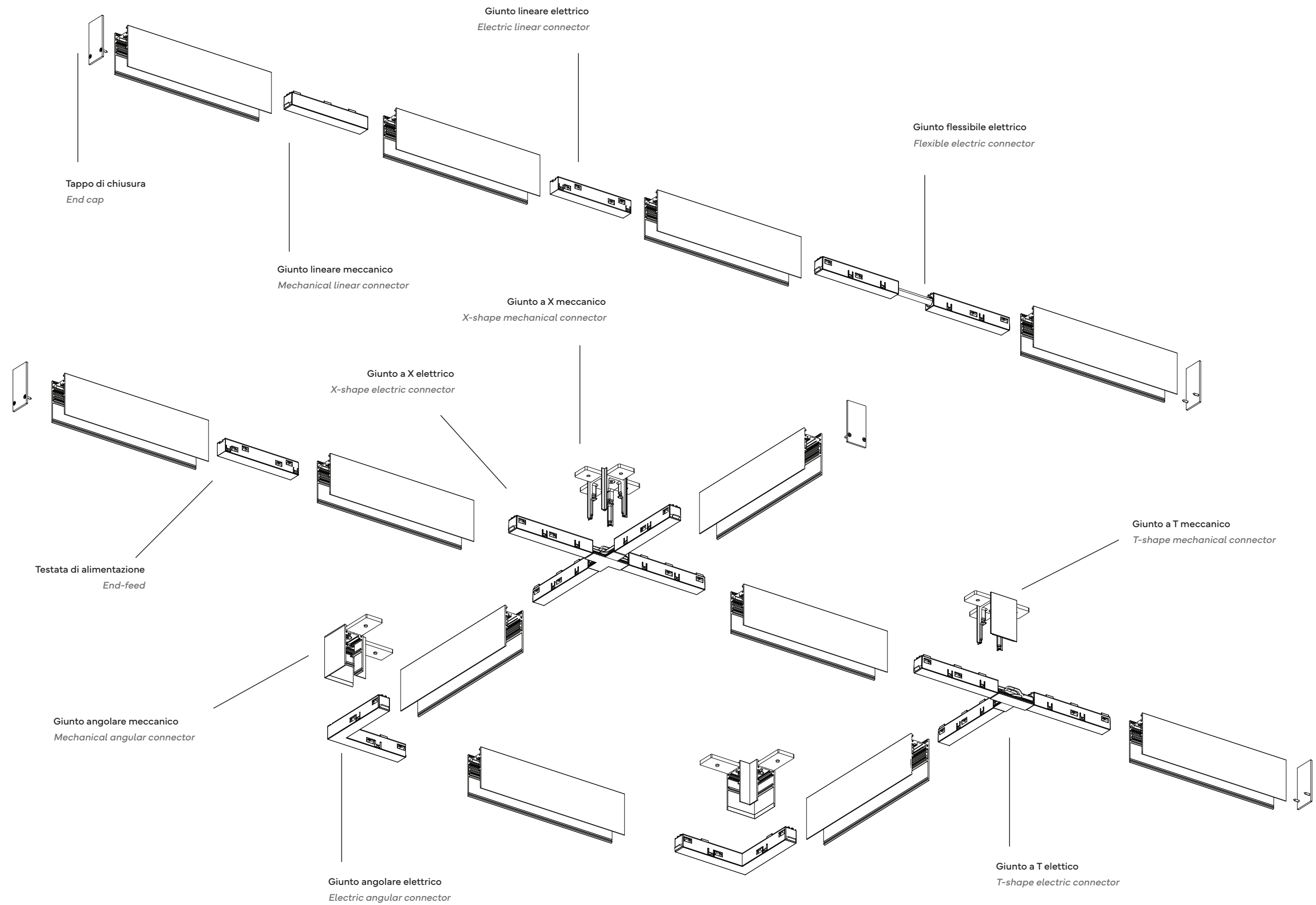

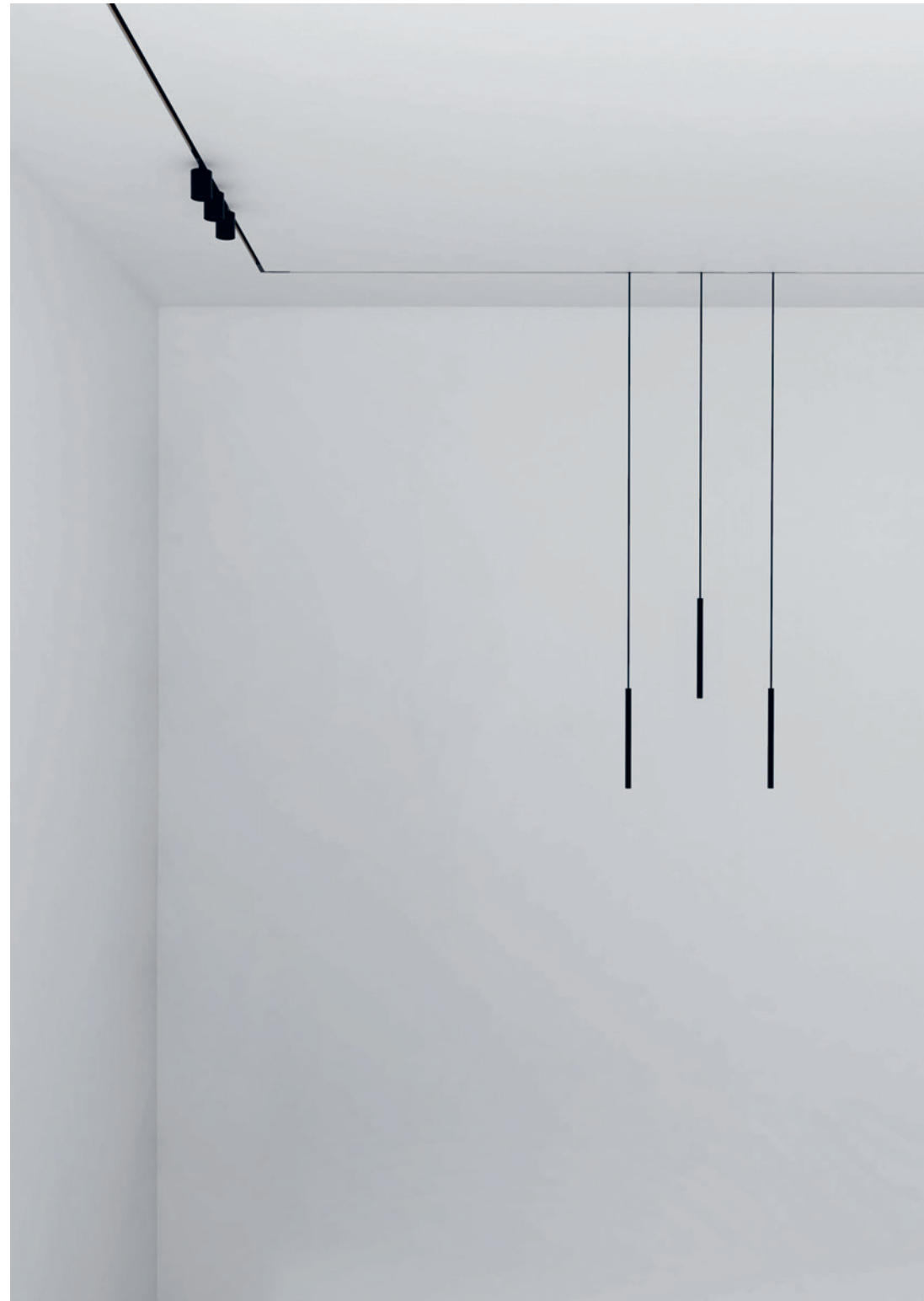

Surface

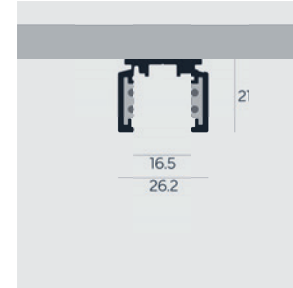

Magic48 - 9630

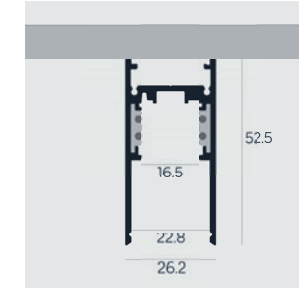

Magic48 - 9635

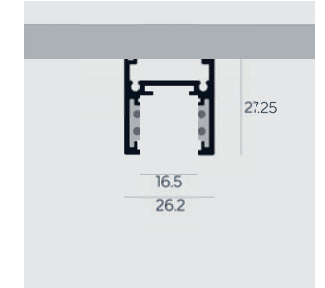

Magic48 - 9655

Suspension

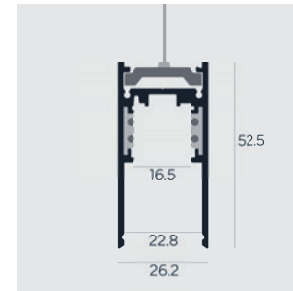

Magic48 - 9635

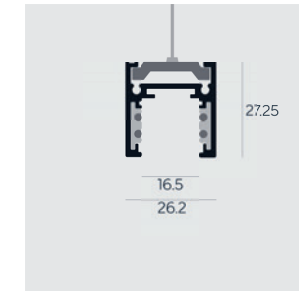

Magic48 - 9655

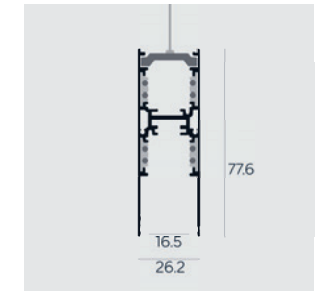

Magic48 - 9665

Recessed

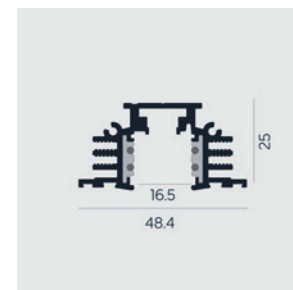

Magic48 - 9640

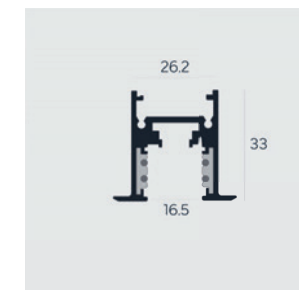

Magic48 - 9645

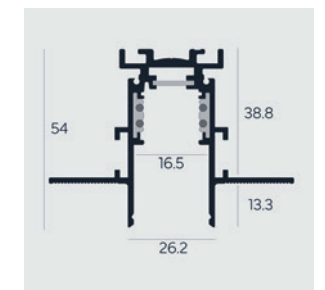

Magic48 - 9650

Magic48 Standard - 9630

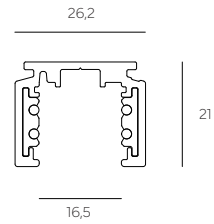

Codice base Base code	Lunghezza mm Length mm	Colore Finishes	Peso Kg Weight Kg
9630	A01 1000	1 Bianco / White	0,7
	A02 2000	2 Nero / Black	1,4
	A03 3000		2,1

Binario elettrificato in estruso di alluminio a bassa tensione per installazione a plafone
Low voltage electrified extruded aluminium track for ceiling installation



Magic48 Deep - 9635

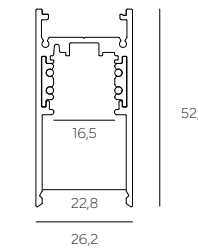
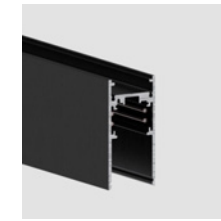

Codice base Base code	Lunghezza mm Length mm	Colore Finishes	Peso Kg Weight Kg
9635	A01 1000	1 Bianco / White	0,9
	A02 2000	2 Nero / Black	1,8
	A03 3000		2,7

Binario elettrificato in estruso di alluminio a bassa tensione per installazione a sospensione, con possibilità di luce indiretta
Low voltage electrified extruded aluminium track for suspended installation. Indirect light available on request



Accessori / Accessories

	Tappo di chiusura / End cap	<input type="checkbox"/>	<input type="checkbox"/>	9630E131	9630E132
	Tappo con foro / End cap with hole	<input type="checkbox"/>	<input type="checkbox"/>	9630E181	9630E182
	Cover estetica (3 mt) / Aesthetic cover (3mt)	<input type="checkbox"/>	<input type="checkbox"/>	9630E161	9630E162
	Rosone per driver (drive non incluso) / Driver box (driver not included)	<input type="checkbox"/>	<input type="checkbox"/>	9630E151	9630E152
	Pinza per taglio conduttori / Cutting tool for conductors	<input type="checkbox"/>		9630EA997	
	*Binario curvo R0,5 mt / Curved track R0,5 mt	<input type="checkbox"/>	<input type="checkbox"/>	9630EC51	9630EC52

NB: La curve hanno solo funzione estetica e di collegamento elettrico, gli adattatori non sono installabili
NB: The curves have aesthetic and electrical connection function only, the adapters cannot be installed

* Dimensioni, raggio e percorso personalizzabili su richiesta /
Curve radius, dimensions and shape customizable on request

Connessioni / Connections

	Testata / End feed	<input type="checkbox"/>	<input type="checkbox"/>	9630E121	9630E122
	Giunto lineare elettrico / Electric linear connector	<input type="checkbox"/>	<input type="checkbox"/>	9630E141	9630E142
	Giunto passante meccanico / Mechanical joint connector	<input type="checkbox"/>	<input type="checkbox"/>	9630E301	9630E302
	Giunto angolare elettrico / Electric angular connector	<input type="checkbox"/>	<input type="checkbox"/>	9630E231	9630E232
	Giunto flessibile elettrico / Electric flexible connector	<input type="checkbox"/>	<input type="checkbox"/>	9630E311	9630E312

Accessori / Accessories

	Tappo di chiusura / End cap	<input type="checkbox"/>	<input type="checkbox"/>	9635E131	9635E132
	Tappo con foro / End cap with hole	<input type="checkbox"/>	<input type="checkbox"/>	9635E181	9635E182
	Cover estetica (3 mt) / Aesthetic cover (3mt)	<input type="checkbox"/>	<input type="checkbox"/>	9635E1731	9635E1732
	Rosone per driver (drive non incluso) / Driver box (driver not included)	<input type="checkbox"/>	<input type="checkbox"/>	9630E151	9630E152
	Giunto angolare meccanico / Angular mechanical joint	<input type="checkbox"/>	<input type="checkbox"/>	9635E281	9635E282
	Giunto a "T" meccanico / "T" mechanical joint	<input type="checkbox"/>	<input type="checkbox"/>	9635E241	9635E242
	Giunto a "X" meccanico / "X" mechanical joint	<input type="checkbox"/>	<input type="checkbox"/>	9635E251	9635E252

Connessioni / Connections

	Testata / End feed	<input type="checkbox"/>	<input type="checkbox"/>	9630E121	9630E122
	Giunto lineare meccanico / Mechanical linear joint	<input type="checkbox"/>		9635E447	
	Giunto lineare elettrico / Electric linear connector	<input type="checkbox"/>	<input type="checkbox"/>	9630E141	9630E142
	Giunto passante meccanico / Mechanical joint connector	<input type="checkbox"/>	<input type="checkbox"/>	9630E301	9630E302
	Giunto angolare elettrico / Electric angular connector	<input type="checkbox"/>	<input type="checkbox"/>	9630E231	9630E232
	Giunto flessibile elettrico / Electric flexible connector	<input type="checkbox"/>	<input type="checkbox"/>	9630E311	9630E312
	Giunto a "T" elettrico / Electric "T" connector	<input type="checkbox"/>	<input type="checkbox"/>	9635E321	9635E322
	Giunto ad "X" meccanico / Mechanical "X" joint	<input type="checkbox"/>	<input type="checkbox"/>	9635E331	9635E332

Kit sospensione e fissaggio / Suspension kits

	Kit sospensione di regolatore e staffa / Suspension kit with gripper and bracket	<input type="checkbox"/>	<input type="checkbox"/>	2 m 9635A627	5 m 9635A657
	Tiges rigida per sospensione 1 m / Tiges 1 m	<input type="checkbox"/>	<input type="checkbox"/>	9635TIG1	9635TIG2
	Rosone con cavo 5 vie L = 2 m / Ceiling rose with 5 poles cable L = 2 m	<input type="checkbox"/>	<input type="checkbox"/>	HSKITROSW	HSKITROSB
	Staffa fissaggio a plafone / Ceiling fixing bracket	<input type="checkbox"/>	<input type="checkbox"/>	9635A211	9635A212

Magic48 Standard - 9655

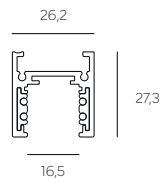

Codice base Base code	Lunghezza mm Length mm	Colore Finishes	Peso Kg Weight Kg
9655	A01 1000	1 Bianco / White	0,8
	A02 2000	2 Nero / Black	1,6
	A03 3000		2,4

Binario elettrificato in estruso di alluminio a bassa tensione per installazione a sospensione, con possibilità di luce indiretta
Low voltage electrified extruded aluminium track for suspended installation. Indirect light available on request



Magic48 Deep - 9665

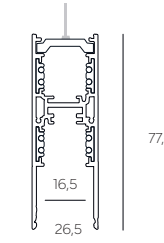
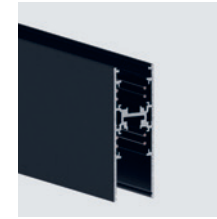

Codice base Base code	Lunghezza mm Length mm	Colore Finishes	Peso Kg Weight Kg
9665	A01 1000	1 Bianco / White	1,1
	A02 2000	2 Nero / Black	2,2
	A03 3000		3,3

Binario elettrificato in estruso di alluminio a bassa tensione per installazione a sospensione, con possibilità di luce indiretta e di proiettore per luce d'accento
Low voltage electrified extruded aluminium track for suspended installation. Indirect and accent light available



Accessori / Accessories

	Tappo di chiusura / End cap	<input type="checkbox"/>	<input type="checkbox"/>	9655E131	9655E132
	Tappo con foro / End cap with hole	<input type="checkbox"/>	<input type="checkbox"/>	9655E181	9655E182
	Cover estetica (3 mt) / Aesthetic cover (3mt)	<input type="checkbox"/>	<input type="checkbox"/>	9630E161	9630E162
	Rosone per driver (drive non incluso) / Driver box (driver not included)	<input type="checkbox"/>	<input type="checkbox"/>	9630E151	9630E152
	Giunto angolare meccanico / Angular mechanical joint	<input type="checkbox"/>	<input type="checkbox"/>	9655E281	9655E282
	Giunto a "T" meccanico / "T" mechanical joint	<input type="checkbox"/>	<input type="checkbox"/>	9655E241	9655E242
	Giunto a "X" meccanico / "X" mechanical joint	<input type="checkbox"/>	<input type="checkbox"/>	9655E251	9655E252

Connessioni / Connections

	Testata / End feed	<input type="checkbox"/>	<input type="checkbox"/>	9630E121	9630E122
	Giunto lineare meccanico / Mechanical linear joint	<input type="checkbox"/>	<input type="checkbox"/>	9635E447	
	Giunto lineare elettrico / Electric linear connector	<input type="checkbox"/>	<input type="checkbox"/>	9630E141	9630E142
	Giunto passante meccanico / Mechanical joint connector	<input type="checkbox"/>	<input type="checkbox"/>	9630E301	9630E302
	Giunto angolare elettrico / Electric angular connector	<input type="checkbox"/>	<input type="checkbox"/>	9630E231	9630E232
	Giunto flessibile elettrico / Electric flexible connector	<input type="checkbox"/>	<input type="checkbox"/>	9630E311	9630E312
	Giunto a "T" elettrico / Electric "T" connector	<input type="checkbox"/>	<input type="checkbox"/>	9635E321	9635E322
	Giunto ad "X" elettrico / Electric "X" joint	<input type="checkbox"/>	<input type="checkbox"/>	9635E331	9635E332

Kit sospensione e fissaggio / Suspension kits

	Kit sospensione di regolatore e staffa / Suspension kit with gripper and bracket	<input type="checkbox"/>	<input type="checkbox"/>	2 m 9635A627	5 m 9635A657
	Rosone con cavo 5 vie L = 2 m / Ceiling rose with 5 poles cable L = 2 m	<input type="checkbox"/>	<input type="checkbox"/>	HSKITROSW	HSKITROSB
	Tiges rigida per sospensione 1 m / Rigid hanger 1 m	<input type="checkbox"/>	<input type="checkbox"/>	9635TIG1	9635TIG2
	Staffa fissaggio a plafone / Ceiling fixing bracket	<input type="checkbox"/>	<input type="checkbox"/>	9635A211	9635A212

Accessori / Accessories

	Tappo di chiusura / End cap	<input type="checkbox"/>	<input type="checkbox"/>	9665E131	9665E132
	Cover estetica (3 mt) / Aesthetic cover (3mt)	<input type="checkbox"/>	<input type="checkbox"/>	9635E1731	9635E1732
	Rosone per driver (drive non incluso) / Driver box (driver not included)	<input type="checkbox"/>	<input type="checkbox"/>	9630E151	9630E152
	Giunto angolare meccanico / Angular mechanical joint	<input type="checkbox"/>	<input type="checkbox"/>	9665E281	9665E282
	Giunto a "T" meccanico / "T" mechanical joint	<input type="checkbox"/>	<input type="checkbox"/>	9665E241	9665E242
	Giunto a "X" meccanico / "X" mechanical joint	<input type="checkbox"/>	<input type="checkbox"/>	9665E251	9665E252

Connessioni / Connections

	Testata / End feed	<input type="checkbox"/>	<input type="checkbox"/>	9630E121	9630E122
	Giunto lineare meccanico / Mechanical linear joint	<input type="checkbox"/>	<input type="checkbox"/>	9635E447	
	Giunto lineare elettrico / Electric linear connector	<input type="checkbox"/>	<input type="checkbox"/>	9630E141	9630E142
	Giunto passante meccanico / Mechanical joint connector	<input type="checkbox"/>	<input type="checkbox"/>	9630E301	9630E302
	Giunto angolare elettrico / Electric angular connector	<input type="checkbox"/>	<input type="checkbox"/>	9630E231	9630E232
	Giunto flessibile elettrico / Electric flexible connector	<input type="checkbox"/>	<input type="checkbox"/>	9630E311	9630E312
	Giunto a "T" elettrico / Electric "T" connector	<input type="checkbox"/>	<input type="checkbox"/>	9635E321	9635E322
	Giunto ad "X" elettrico / Electric "X" joint	<input type="checkbox"/>	<input type="checkbox"/>	9635E331	9635E332

Kit sospensione e fissaggio / Suspension kits

	Kit sospensione di regolatore e staffa / Suspension kit with gripper and bracket	<input type="checkbox"/>	<input type="checkbox"/>	2 m 9635A627	5 m 9635A657
	Rosone con cavo 5 vie L = 2 m / Ceiling rose with 5 poles cable L = 2 m	<input type="checkbox"/>	<input type="checkbox"/>	HSKITROSW	HSKITROSB
	Tiges rigida per sospensione 1 m / Rigid hanger 1 m	<input type="checkbox"/>	<input type="checkbox"/>	9635TIG1	9635TIG2
	Staffa fissaggio a plafone / Ceiling fixing bracket	<input type="checkbox"/>	<input type="checkbox"/>	9635A211	9635A212

Magic48 Recessed Trimless - 9640

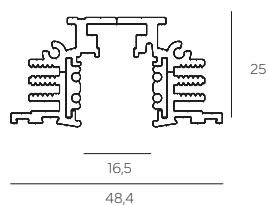

Codice base Base code	Lunghezza mm Length mm	Colore Finishes	Peso Kg Weight Kg
9640	A01 1000	1 Bianco / White	0,7
	A02 2000	2 Nero / Black	1,4
	A03 3000		2,1

Binario elettrificato in estruso di alluminio a bassa tensione per installazione ad incasso per cartongesso da posare
Low voltage electrified extruded aluminium track for trimless installation, plasterboard to be installed



Magic48 Recessed Trim - 9645

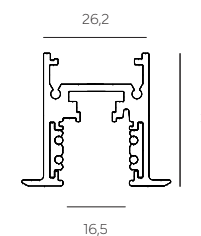

Codice base Base code	Lunghezza mm Length mm	Colore Finishes	Peso Kg Weight Kg
9645	A01 1000	1 Bianco / White	0,7
	A02 2000	2 Nero / Black	1,4
	A03 3000		2,1

Binario in estruso di alluminio a bassa tensione per installazione ad incasso con cornice per cartongesso già posato
Low voltage electrified extruded aluminium track for trim installation on plasterboard already assembled



Accessori / Accessories

	Tappo di chiusura / End cap	<input type="checkbox"/>	<input type="checkbox"/>	9640E131	9640E132
	Staffa di fissaggio (1 pezzo) / Fixing bracket (1 piece)	<input type="checkbox"/>		9640E133	
	Cover estetica (3 mt) / Aesthetic cover (3mt)	<input type="checkbox"/>	<input type="checkbox"/>	9630E161	9630E162

Connessioni / Connections

	Testata / End feed	<input type="checkbox"/>	<input type="checkbox"/>	9630E121	9630E122
	Giunto lineare elettrico / Electric linear connector	<input type="checkbox"/>	<input type="checkbox"/>	9630E141	9630E142
	Giunto passante meccanico / Mechanical joint connector	<input type="checkbox"/>	<input type="checkbox"/>	9630E301	9630E302
	Giunto angolare elettrico / Electric angular connector	<input type="checkbox"/>	<input type="checkbox"/>	9630E231	9630E232
	Giunto flessibile elettrico / Electric flexible connector	<input type="checkbox"/>	<input type="checkbox"/>	9630E311	9630E312

Accessori / Accessories

	Tappo di chiusura / End cap	<input type="checkbox"/>	<input type="checkbox"/>	9645E131	9645E132
	Staffa di fissaggio (1 pezzo) / Fixing bracket (1 piece)	<input type="checkbox"/>		9645E133	
	Cover estetica (3 mt) / Aesthetic cover (3mt)	<input type="checkbox"/>	<input type="checkbox"/>	9630E161	9630E162

Connessioni / Connections

	Testata / End feed	<input type="checkbox"/>	<input type="checkbox"/>	9630E121	9630E122
	Giunto lineare elettrico / Electric linear connector	<input type="checkbox"/>	<input type="checkbox"/>	9630E141	9630E142
	Giunto passante meccanico / Mechanical joint connector	<input type="checkbox"/>	<input type="checkbox"/>	9630E301	9630E302
	Giunto angolare elettrico / Electric angular connector	<input type="checkbox"/>	<input type="checkbox"/>	9630E231	9630E232
	Giunto flessibile elettrico / Electric flexible connector	<input type="checkbox"/>	<input type="checkbox"/>	9630E311	9630E312

Magic48 Recessed Trimless Deep - 9650

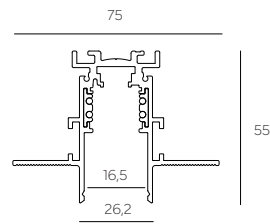

Codice base Base code	Lunghezza mm Length mm	Colore Finishes	Peso Kg Weight Kg
9650	A01 1000	1 Bianco / White	0,7
	A02 2000	2 Nero / Black	1,4
	A03 3000		2,1

Binario elettrificato in estruso di alluminio a bassa tensione per installazione ad incasso per cartongesso da posare
Low voltage electrified extruded aluminium track for trimless installation, plasterboard to be installed



Accessori / Accessories

	Tappo di chiusura / End cap	<input type="checkbox"/> 9635E131	<input checked="" type="checkbox"/> 9635E132
	Tappo con foro / End cap with hole	<input type="checkbox"/> 9635E181	<input checked="" type="checkbox"/> 9635E182
	Cover estetica (3 mt) / Aesthetic cover (3mt)	<input type="checkbox"/> 9635E1731	<input checked="" type="checkbox"/> 9635E1732
	Giunto angolare meccanico (soffitto-soffitto) / Angular mechanical joint (ceiling-ceiling)	<input type="checkbox"/> 9650E281	<input checked="" type="checkbox"/> 9650E282
	Giunto angolare meccanico (parete-soffitto) / Angular mechanical joint (wall-ceiling)	<input type="checkbox"/> 9650E271	<input checked="" type="checkbox"/> 9650E272

Connessioni / Connections

	Testata / End feed	<input type="checkbox"/> 9630E121	<input checked="" type="checkbox"/> 9630E122
	Giunto lineare meccanico / Mechanical linear joint	<input type="checkbox"/> 9650E411	<input checked="" type="checkbox"/> 9650E412
	Giunto lineare elettrico / Electric linear connector	<input type="checkbox"/> 9630E141	<input checked="" type="checkbox"/> 9630E142
	Giunto passante meccanico / Mechanical joint connector	<input type="checkbox"/> 9630E301	<input checked="" type="checkbox"/> 9630E302
	Giunto angolare elettrico / Electric angular connector	<input type="checkbox"/> 9630E231	<input checked="" type="checkbox"/> 9630E232
	Giunto flessibile elettrico / Electric flexible connector	<input type="checkbox"/> 9630E311	<input checked="" type="checkbox"/> 9630E312

Componenti elettriche
Electric components

Alimentatori 48V
48V Drivers

Alimentatore re moto 70W <i>70W Remote driver</i>	122786	181x46x25mm
Alimentatore remoto 150W <i>150W Remote driver</i>	127356	240x59x40mm
Alimentatore remoto 240W <i>240W Remote driver</i>	XLG-240-H-ADI	219x63x35mm
Alimentatore integrato a binario 100W <i>100W In-track driver (feed included)</i>	INTR100B <input checked="" type="checkbox"/> INTR100W <input type="checkbox"/>	300x16x19mm
Alimentatore integrato a binario 250W <i>250W In-track driver (feed included)</i>	INTR250B <input checked="" type="checkbox"/> INTR250W <input type="checkbox"/>	300x22x43mm

Interfacce di controllo
Dimming interfaces

Ripetitore opto isolante del segnale DALI* <i>DALI opto isolator repeater*</i>	S-RP-24-48V	180X42X29mm
Interfaccia per dimmerazione Push N/A (per dimmerare prodotti standard) <i>Push N/O interface (to dim standard products)</i>	MINI-1CV	44X44X29mm

Luce indiretta - solo binario 9635 e 9655
Indirect light - 9635 and 9655 tracks only

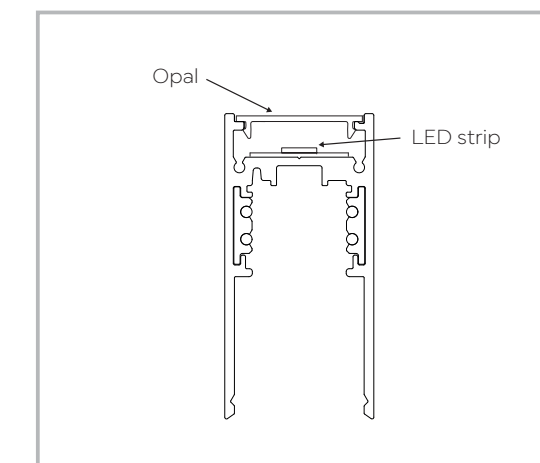

LED strip 24V - 5m
14,4 W/m - 1300 lm/m

2700K	SV2700
3000K	SV3000
4000K	SV4000

22 W/m - 2700 lm/m

2700K	SK2700
3000K	SK3000
4000K	SK4000

Driver 24V

60 W
100 W
150 W

Opale
Opal

1 m	9635OPAL1
2 m	9635OPAL2
3 m	9635OPAL3

On/Off DALI

SL60-24VF	SDL60-24VF
SL100-24VF	SDL100-24VF
SNP150-24VF	SDL150-24VF

Configurazioni elettriche Electric configurations

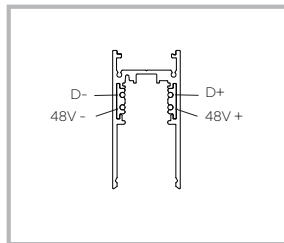

Il collegamento Dali avviene come in figura. Il segnale derivante dal sistema di controllo viene connesso direttamente sulla testata, permettendo così l'apprendimento di ogni singolo indirizzo. I driver di alimentazione non devono essere previsti in versione dimmerabile DALI.

DALI connection to be made as per below picture. DALI system connection must be done directly into the end-feed; each DALI address will be detected by the Bus. Power supply must be provided in on/off version.

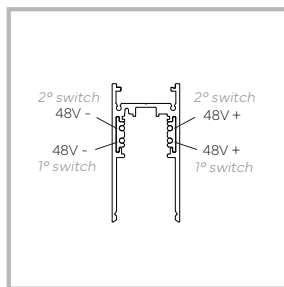

A richiesta è possibile realizzare sistemi Magic48 con due accensioni separate, sfruttando i contatti, solitamente dedicati alla dimmerazione, come in figura. E' necessario comunicare in fase d'ordine la divisione degli apparecchi, poiché non è possibile modificarne l'alimentazione a fornitura ultimata. La dimmerazione Push in doppia accensione è la sola opzione realizzabile con questa configurazione.

On request is possible to have double switching installation on Magic48 system by using the conductors usually dedicated to dimming signal. Luminaries switching division must be communicated on order, it is not possible to modify the switching features on site. Push dimming is the only dimming option available with this configuration.

Schemi di collegamento della dimmerazione Dimming wiring schemes

Ripetitore opto isolante del segnale DALI / DALI opto isolator repeater

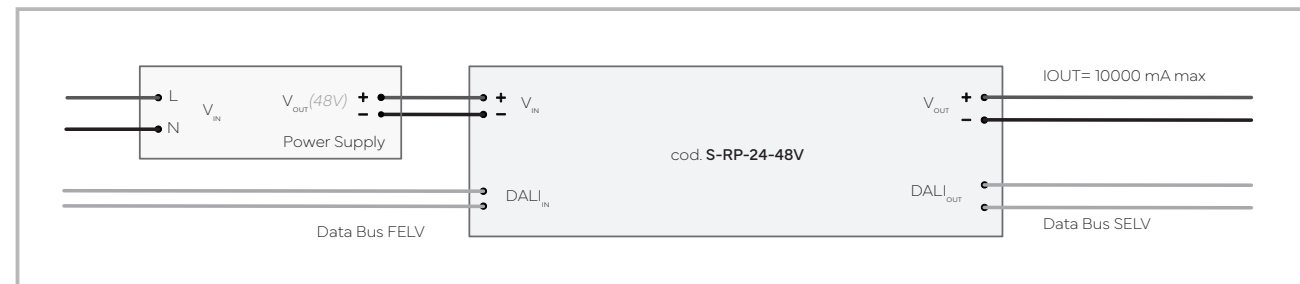

Dispositivo consigliato nel caso di utilizzo del segnale DALI, per convertirlo in segnale digitale SELV, e per protezione contro i picchi di tensione all'ingresso e in uscita. / Recommended device when using the DALI signal, to convert it into a SELV digital signal, and to protect against input and output voltage peaks.

Interfaccia per dimmerazione Push N/A (per dimmerare prodotti standard) / Push N/O interface (to dim standard products)

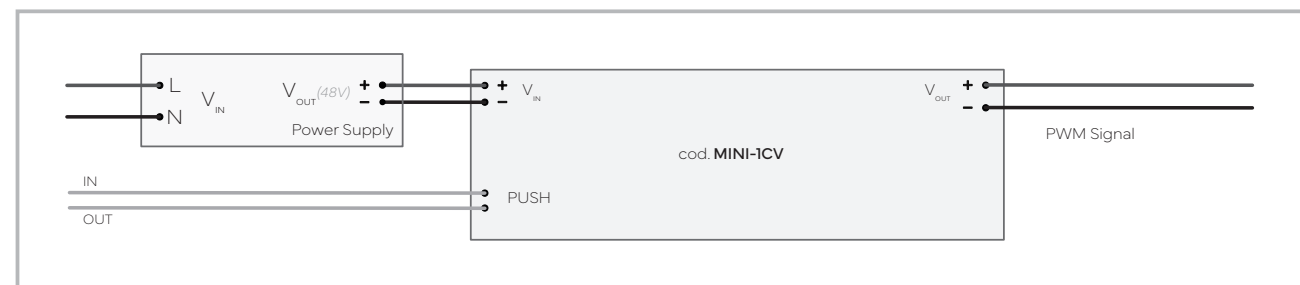

Avvertenze di installazione Installation notice

La tabella seguente riporta i dati di distanza e di carico massimo applicabili alle installazioni che prevedono il sistema Magic48. Nel caso non si rispettino le indicazioni riportate di seguito, il corretto funzionamento del prodotto non è garantito. Tali limitazioni sono strettamente legate alla caduta di tensione sulle linee.

The table below displays the maximum loads and distances installations for Magic48 system. If these limits are not respected, correct operation of the product is not guaranteed. These limitations are directly related to the voltage drop.

[W] Portata alimentatore Power supplied	Distanza alimentatore/Testata di alimentazione (2x1.5 mm2 - 2xAWG16) Distance between Power supply/End-feed (2x1.5 mm2 - 2xAWG16)			
	5 m	10 m	20 m	30 m
Lunghezza Binario / Track length (mt)				
60	50	50	50	50
100	50	50	40	25
150	50	40	20	N/D
200	40	30	N/D	N/D
250	35	20	N/D	N/D

Capacità di carico Load capacity

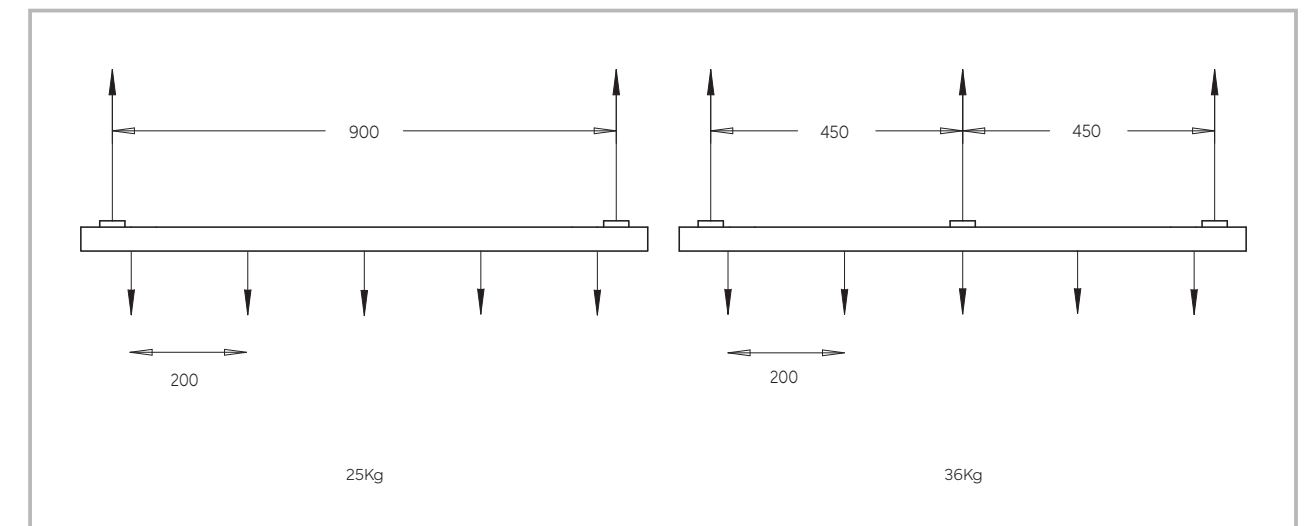

I binari Magic48 possono sopportare un carico di 25 kg con una distanza massima fra i punti di fissaggio di 900 mm e un carico di 36 kg con una distanza di fissaggio di 450 mm.

Magic48 tracks have a load capacity of 25 kg with a maximum distance of 900 mm among their fixing points and a load of 36 kg with a fixing distance of 450 mm.



Magic Otto

La linea di proiettori Otto per binario a 48V è il risultato di un'attenta fase progettuale, sia dal punto di vista tecnologico che del design. Otto 60 è pensato principalmente per l'applicazione nel mondo del retail di alta gamma. Otto40, grazie alle dimensioni minimali, si presta principalmente per applicazioni in ambito residenziale e ricettivo.

Otto floodlights series is the result of a careful design phase, both in terms of technology and design. Otto60 is primarily intended for application in the high-end retail. Otto40 is mainly suited for residential and hospitality applications, thanks to its minimalist dimensions.

Magic Otto 40



Up to 10.5W

Caratteristiche illuminotecniche / Lighting specs

Watt	Watt LED	mA	IRC/CRI	CCTs	Nom lm	Del lm
10.5	9	250	>90	2700K 3000K 4000K	986 1041 1112	790 833 889

Codice base Base code	Temperatura Temperature	Potenza Power	Fascio Beam	Finitura Finishing	Alimentazione Driver
8008	Z 2700K	A 10.5W	C 15°	1 Bianco White	E On-Off
	7 3000K		H 26°	L DALI	
	8 4000K		L 36°	2 Nero Black	C Casambi
			T 60°		

* A richiesta è possibile configurare il prodotto con LED speciali e temperature colore dedicate.
Special LEDs and specific colour temperatures can be configured on request.

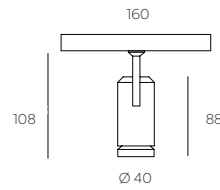
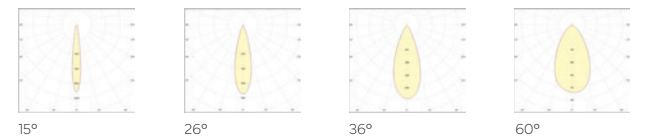

0,2 Kg

Bianco
White

Nero
Black

Finiture custom
Custom finishes

Magic Otto 60



Up to 19.5W

Caratteristiche illuminotecniche / Lighting specs

Watt	Watt LED	mA	IRC/CRI	CCTs	Nom lm	Del lm
13.5	12	350	>90	2700K 3000K 4000K	1521 1621 1752	1217 1297 1402
19.5	17.5	500	>90	2700K 3000K 4000K	2069 2205 2384	1653 1762 1905

Codice base Base code	Temperatura Temperature	Potenza Power	Fascio Beam	Finitura Finishing	Alimentazione Driver
8009	Z 2700K	B 13.5W C 19.5W	C 15°	1 Bianco White	E On-Off
	7 3000K		H 26°	L DALI	
	8 4000K		L 36°	2 Nero Black	C Casambi
			T 60°		

* A richiesta è possibile configurare il prodotto con LED speciali e temperature colore dedicate.
Special LEDs and specific colour temperatures can be configured on request.

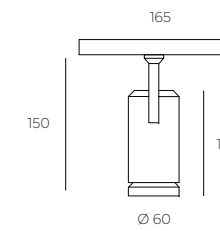
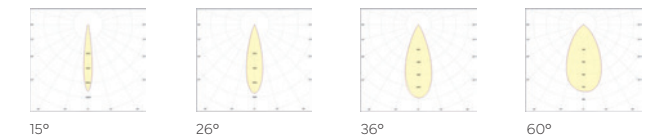

0,3 Kg

Bianco
White

Nero
Black

Finiture custom
Custom finishes

Accessori / Accessories

<p>Frangiluce alveolare Honeycomb</p> <p>8008GRI</p>	<p>Frangiluce a croce Cross-blade visor</p> <p>8008CR</p>	<p>Filtro diffondente Diffuse filter</p> <p>8008DI</p>	<p>Visore cilindrico Cylindric visor</p> <p>8008VC</p>	<p>Lenti Lenses</p> <p>15° 800815 26° 800826 36° 800836 60° 800860</p>
--	---	--	--	--

Accessori / Accessories

<p>Frangiluce alveolare Honeycomb</p> <p>8006GRI</p>	<p>Frangiluce a croce Cross-blade visor</p> <p>8006CR</p>	<p>Filtro diffondente Diffuse filter</p> <p>8006DI</p>	<p>Filtro ovale Oval filter</p> <p>8006OV</p>	<p>Visore cilindrico Cylindric visor</p> <p>8006VC</p>
<p>Visore 45° 45° Visor</p> <p>8006VO</p>	<p>Lenti Lenses</p> <p>15° 800615 26° 800626 36° 800636 60° 800660</p>			

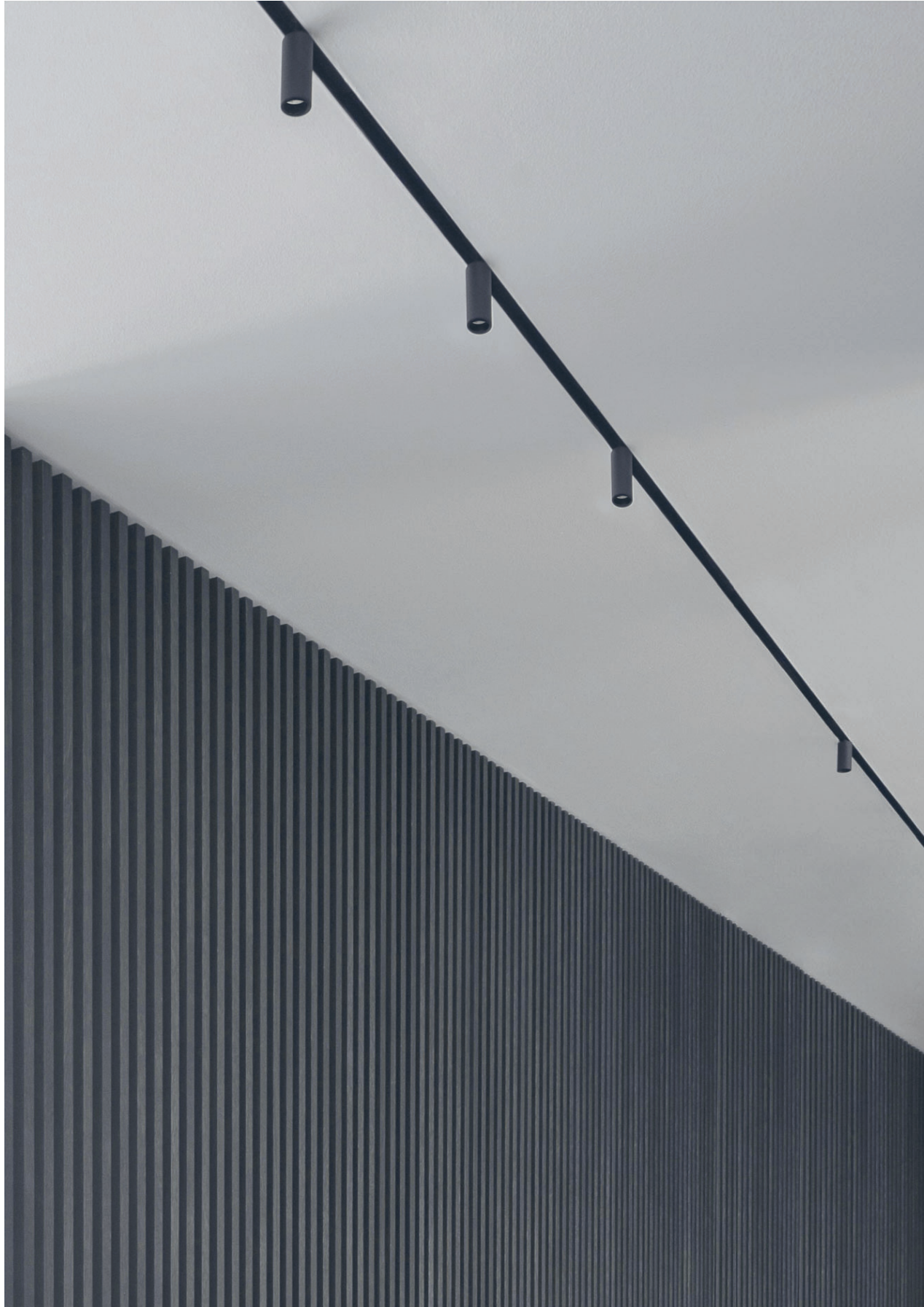

Magic spot

Magic Spot è la nuova gamma di proiettori per binario 48V, composta da cinque diverse dimensioni. La versione più piccola, con un diametro di 35 mm, offre una potenza di 8W, mentre la più grande da 70 mm raggiunge i 25W. La linea è principalmente destinata all'uso residenziale e al settore alberghiero e può essere personalizzata in base alle finiture disponibili.

Magic Spot is the new range of 48V track lights, with five different sizes. The smallest version, with a diameter of 35 mm, offers 8W power, while the 70 mm version reaches 25W power. It is mainly intended for residential and hospitality and can be customized according to the available finishes.



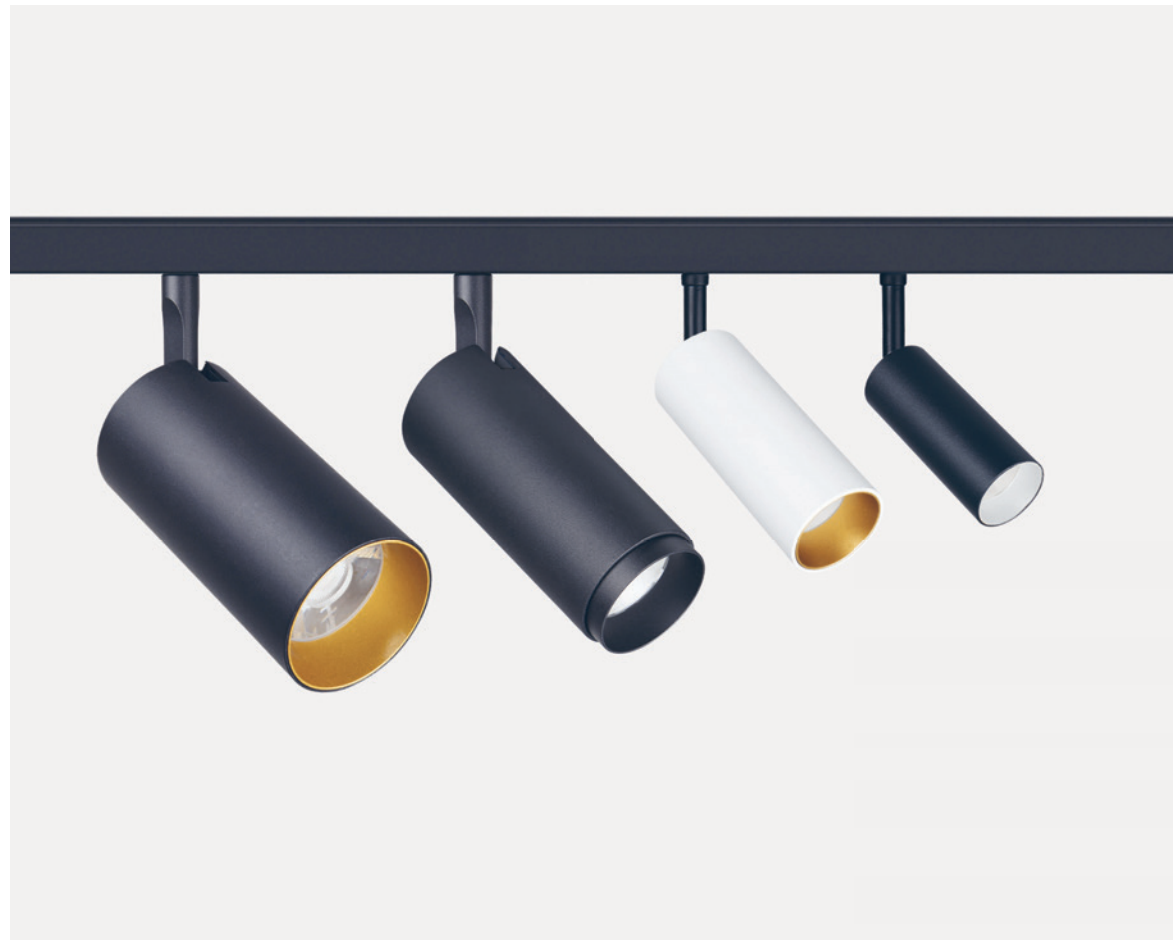

Il prodotto è disponibile in 3 configurazioni: bianco, nero e una versione speciale con corpo bianco e adattatore e tige nera. Inoltre, è possibile sostituire l'anello frontale nelle colorazioni opzionali nero, bianco ed oro.

The product is available in three configurations: total white or black and a special version with a white body and black adapter and tige. In addition, it is possible to replace the front ring with the optional black, white and gold colours.

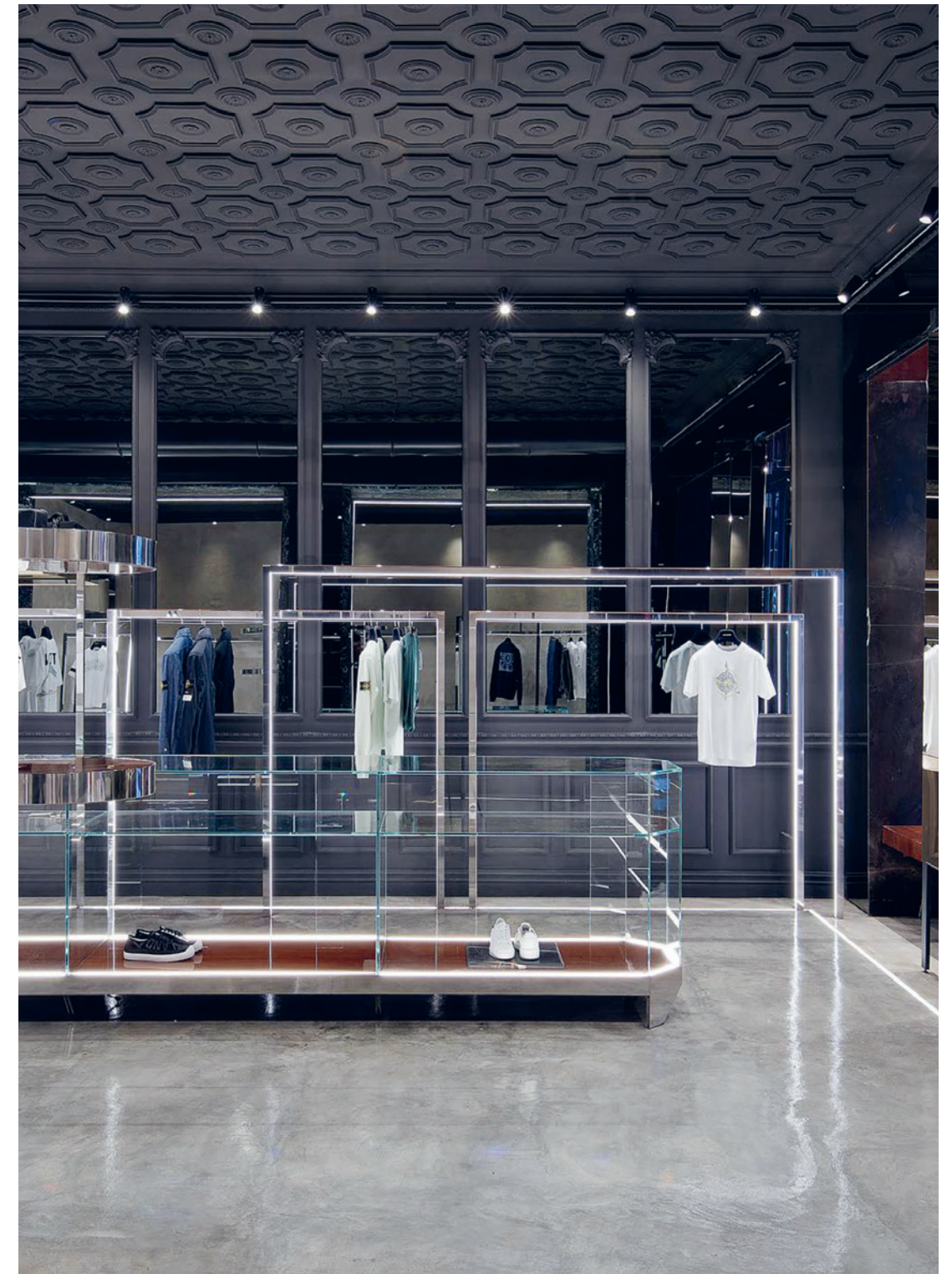



Magic Spot 35

8 W

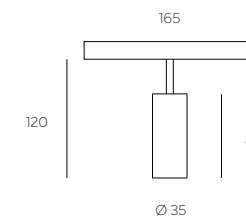

0,2 Kg

Bianco
 White
 Nero
 Black

Caratteristiche illuminotecniche / Lighting specs

Watt	Watt LED	mA	IRC/CRI	CCTs	Nom lm	Del lm
8	7.2	200	>90	2700K	784	517
				3000K	840	537
				4000K	880	554

Codice base Base code	Temperatura Temperature	Potenza Power	Fascio Beam	Finitura Finishing	Alimentazione Driver
8001	Z 2700K	2 8W	E 20°	1 Bianco/Nero White/Black	E On-Off
	7 3000K		L 36°		
	8 4000K		R 50°	9 Tutto Bianco All White	C Casambi
				2 Nero Black	

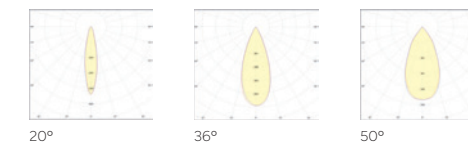

P20
48 V
CV
RG1
CE
T_a
25 °C
355°
90°
5 Warranty up to **years**

Magic Spot 45

12 W

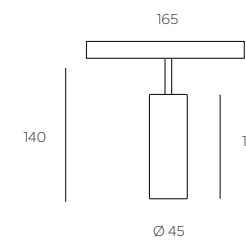
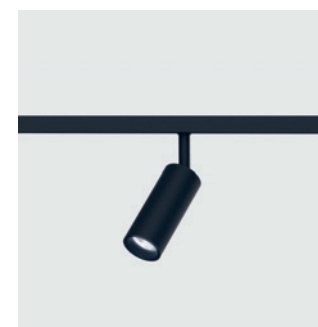

0,3 Kg

Bianco
 White
 Nero
 Black

Caratteristiche illuminotecniche / Lighting specs

Watt	Watt LED	mA	IRC/CRI	CCTs	Nom lm	Del lm
12	10.8	300	>90	2700K	1176	800
				3000K	1260	857
				4000K	1320	898

Codice base Base code	Temperatura Temperature	Potenza Power	Fascio Beam	Finitura Finishing	Alimentazione Driver
8002	Z 2700K	3 12W	3 18°	1 Bianco/Nero White/Black	E On-Off
	7 3000K		L 36°		
	8 4000K		T 60°	9 Tutto Bianco All White	C Casambi
				2 Nero Black	

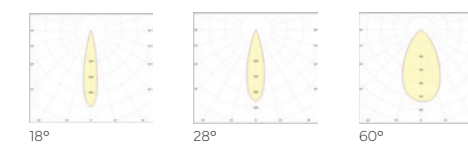

P20
48 V
CV
RG1
CE
T_a
25 °C
355°
90°
5 Warranty up to **years**

Magic Spot 55

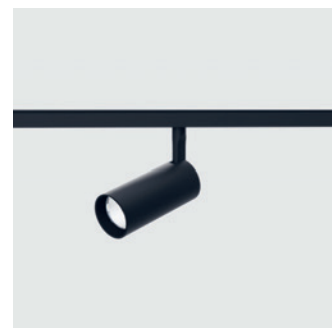

15 W

Caratteristiche illuminotecniche / Lighting specs

Watt	Watt LED	mA	IRC/CRI	CCTs	Nom lm	Del lm
15	12.5	350	>90	2700K	1470	1132
				3000K	1575	1213
				4000K	1650	1271

Codice base Base code	Temperatura Temperature	Potenza Power	Fascio Beam	Finitura Finishing	Alimentazione Driver
8003	Z 2700K 7 3000K 8 4000K	B 15W	C 15° L 36° R 50°	1 Bianco/Nero White/Black 9 Tutto Bianco All White 2 Nero Black	E On-Off L DALI C Casambi

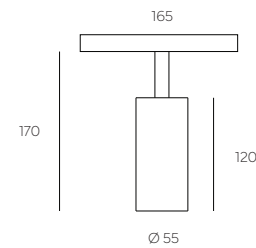
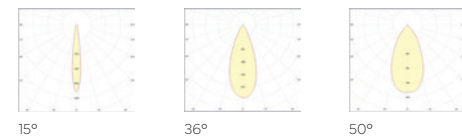

0,3 Kg

Bianco
White
Nero
Black

Magic Spot 70



25 W

Caratteristiche illuminotecniche / Lighting specs

Watt	Watt LED	mA	IRC/CRI	CCTs	Nom lm	Del lm
25	21.6	600	>90	2700K	3200	1888
				3000K	3350	1977
				4000K	3550	2095

Codice base Base code	Temperatura Temperature	Potenza Power	Fascio Beam	Finitura Finishing	Alimentazione Driver
8004	Z 2700K 7 3000K 8 4000K	Q 25W	C 15° L 36° T 60°	1 Bianco/Nero White/Black 9 Tutto Bianco All White 2 Nero Black	E On-Off L DALI C Casambi

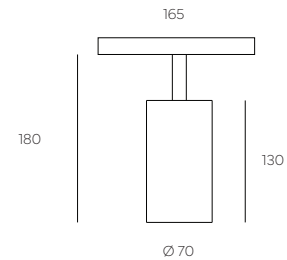
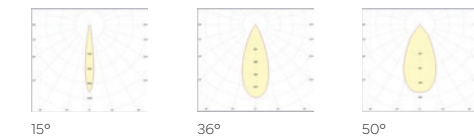

0,6 Kg

Bianco
White
Nero
Black

Magic Spot 55 Zoom



15 W

Caratteristiche illuminotecniche / Lighting specs

Watt	Watt LED	mA	IRC/CRI	CCTs	Nom lm	Del lm
15	12.5	350	>90	3000K	1575	1253 (@36°)
				4000K	1650	1313 (@36°)

Codice base Base code	Temperatura Temperature	Potenza Power	Fascio Beam	Finitura Finishing	Alimentazione Driver
8011	7 3000K 8 4000K	B 15W	X 15°-36°	1 Bianco/Nero White/Black 9 Tutto Bianco All White 2 Nero Black	E On-Off L DALI C Casambi

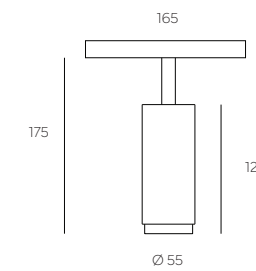
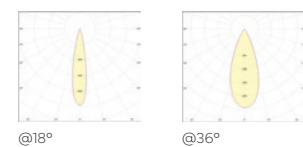

0,4 Kg

Bianco
White
Nero
Black

Accessori / Accessories

Frangiluce
Honeycomb

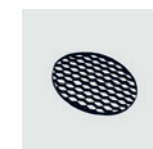

Magic Spot 35 8001GRI
Magic Spot 45 8002GRI
Magic Spot 55 8003GRI
Magic Spot 70 8004GRI

Riflettore Nero
Black Reflector



Magic Spot 35 800111
Magic Spot 45 800211
Magic Spot 55 800311
Magic Spot 70 800411

Riflettore Bianco
White Reflector



Magic Spot 35 800110
Magic Spot 45 800210
Magic Spot 55 800310
Magic Spot 70 800410

Riflettore Oro
Gold Reflector

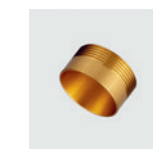

Magic Spot 35 800114
Magic Spot 45 800214
Magic Spot 55 800314
Magic Spot 70 800414



Magic K

Magic K, disponibile in due lunghezze, è realizzato in alluminio estruso e può essere personalizzato con diverse verniciature o finiture galvaniche. Grazie all'assenza di elementi plastici, presenta un design pulito e minimale, integrandosi discretamente negli ambienti.

Available in two lengths, Magic K is made from extruded aluminum and can be customized with a variety of finishes, both painted and galvanized. Thanks to the absence of plastic elements, it has a clean and minimalist design that blends discreetly into every environment.

Magic K/XS



8 W

Caratteristiche illuminotecniche / Lighting specs

Watt	Watt LED	mA	IRC/CRI	CCTs	Nom lm	Del lm
8	7.8	250	>90	2700K 3000K 4000K	1124 1182 1242	861 905 951

Codice base Base code	Temperatura Temperature	Potenza Power	Fascio Beam	Finitura Finishing	Alimentazione Driver
2045	Z 2700K	A 8W	B 12°	1 Bianco White	E On-Off
	7 3000K		F 24°	L DALI	
	8 4000K		M 38°	2 Nero Black	C Casambi
			T 60°		

NB: per installazioni su binari con linea conduttori recessata (9635, 9665, 9650) ordinare il seguente codice
NB: for installation on tracks with recessed conductor lines (9635, 9665, 9650) order the following code

Codice base Base code	Temperatura Temperature	Potenza Power	Fascio Beam	Finitura Finishing	Alimentazione Driver
2047	Z 2700K	A 8W	B 12°	1 Bianco White	E On-Off
	7 3000K		F 24°	L DALI	
	8 4000K		M 38°	2 Nero Black	C Casambi
			T 60°		

* A richiesta è possibile configurare il prodotto con LED speciali e temperature colore dedicate.
Special LEDs and specific colour temperatures can be configured on request.

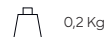
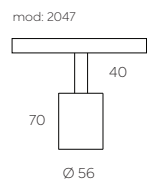
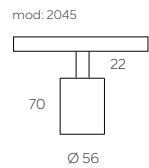

0,2 Kg

- Bianco
White
- Nero
Black

Finiture custom
Custom finishes

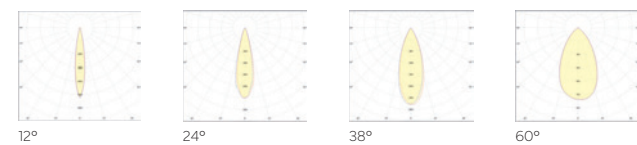

Accessori / Accessories

Frangiluce
Honeycomb

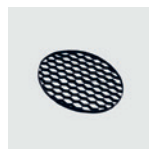

Magic K/XS KSGRI

Lenti
Lenses

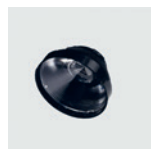

Magic K/XS

- 12° 202512
- 24° 202524
- 38° 202538
- 60° 202560

Magic K/S



Up to
18 W

Caratteristiche illuminotecniche / Lighting specs

Watt	Watt LED	mA	IRC/CRI	CCTs	Nom lm	Del lm
12.5	11.8	350	>90	2700K 3000K 4000K	1539 1618 1700	1179 1239 1302

18	17.4	500	>90	2700K 3000K 4000K	2124 2235 2347	1627 1712 1798
----	------	-----	-----	-------------------------	----------------------	----------------------

Codice base Base code	Temperatura Temperature	Potenza Power	Fascio Beam	Finitura Finishing	Alimentazione Driver
2035	Z 2700K	B 12.5W C 18W	B 12°	1 Bianco White	E On-Off
	7 3000K		F 24°	L DALI	
	8 4000K		M 38°	2 Nero Black	C Casambi
			T 60°		

NB: per installazioni su binari con linea conduttori recessata (9635, 9665, 9650) ordinare il seguente codice
NB: for installation on tracks with recessed conductor lines (9635, 9665, 9650) order the following code

Codice base Base code	Temperatura Temperature	Potenza Power	Fascio Beam	Finitura Finishing	Alimentazione Driver
2037	Z 2700K	B 12.5W C 18W	B 12°	1 Bianco White	E On-Off
	7 3000K		F 24°	L DALI	
	8 4000K		M 38°	2 Nero Black	C Casambi
			T 60°		

* A richiesta è possibile configurare il prodotto con LED speciali e temperature colore dedicate.
Special LEDs and specific colour temperatures can be configured on request.

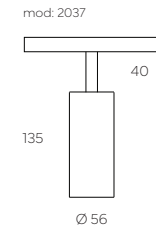
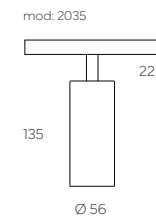

0,5 Kg

- Bianco
White
- Nero
Black

Finiture custom
Custom finishes

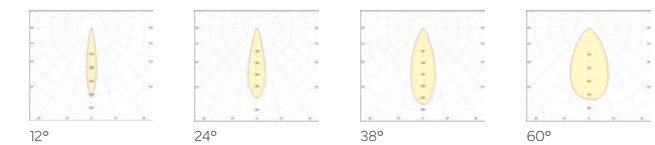

Accessori / Accessories

Frangiluce
Honeycomb

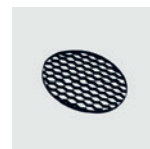

Magic K/S KSGRI

Lenti
Lenses

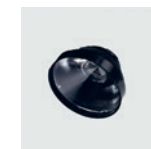

Magic K/XS

- 12° 202512
- 24° 202524
- 38° 202538
- 60° 202560



Magic Point & Mini

Magic Point e Magic Mini sono proiettori miniaturizzati concepiti per l'uso residenziale e per progetti museali e di gioielleria. Rispetto ai prodotti standard, questi due proiettori offrono una gamma di temperature colore ed ottiche più vasta. Spesso combinati in varie configurazioni di temperatura, sono ampiamente utilizzati per illuminare teche espositive.

Magic Point and Magic Mini are spotlights designed for residential use, museums, and jewelry projects. They offer a wider range of color temperatures and optics compared to standard products. They are often combined in various temperature configurations and are widely used to illuminate store windows and museum showcases.



Magic Point

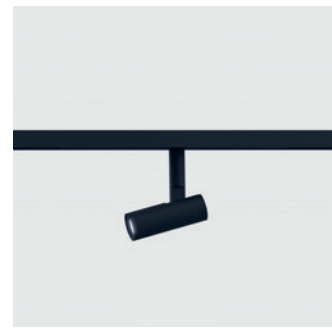

2 W

Caratteristiche illuminotecniche / Lighting specs

Watt	Watt LED	mA	IRC/CRI	CCTs	Nom lm	Del lm
2	1.7	600	>90	2700K	348	162
				3000K	348	162
				3500K	348	162
				4000K	348	162

Codice base Base code	Temperatura Temperature	Potenza Power	Fascio Beam	Finitura Finishing	Alimentazione Driver
2036	Z 2700K	Q 2W	B 25°	1 Bianco White	E On-Off
	7 3000K		D 40°		L DALI
	0 3500K		E 60°	2 Nero Black	
	8 4000K		F 80°		

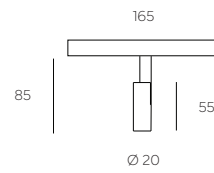

0,1 Kg

Bianco
White
Nero
Black

Finiture custom
Custom finishes

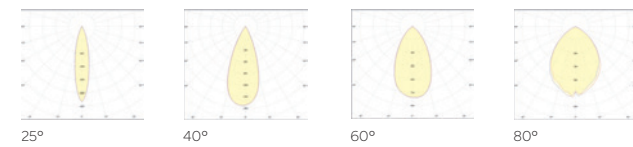

IP20, 48 V CV, RG1, CE, Ta 25 °C, 355°, 90°, Warranty up to 5 years

Magic Mini

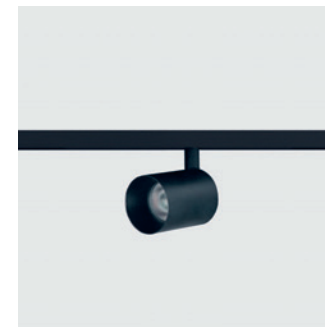

8 W

Caratteristiche illuminotecniche / Lighting specs

Watt	Watt LED	mA	IRC/CRI	CCTs	Nom lm	Del lm
8	7	600	>90	2700K	952	762
				3000K	984	787
				4000K	1068	855

Codice base Base code	Temperatura Temperature	Potenza Power	Fascio Beam	Finitura Finishing	Alimentazione Driver
2048	Z 2700K	Q 8W	F 24°	1 Bianco White	E On-Off
	7 3000K		S 55°		L DALI
	8 4000K			2 Nero Black	C Casambi

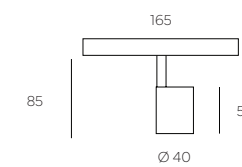

0,2 Kg

Bianco
White
Nero
Black

Finiture custom
Custom finishes

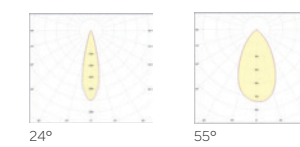

IP20, 48 V CV, RG1, CE, Ta 25 °C, 355°, 90°, Warranty up to 5 years



Magic pendant

Due prodotti a sospensione completano la serie per l'installazione sui sistemi Magic48. Magic K/S è ideato per illuminare superfici che richiedono un'illuminazione d'accento e una maggiore potenza. Magic Ice, più piccolo e minimalista, è pensato per applicazioni in cui la decorazione è di primaria importanza.

Two pendant products complete the series for Magic48 systems. Magic K/S is designed to illuminate surfaces requiring accent lighting and higher power. The smaller and more minimalist Magic Ice is designed for applications where decoration is of primary importance.

Magic K/S Pendant

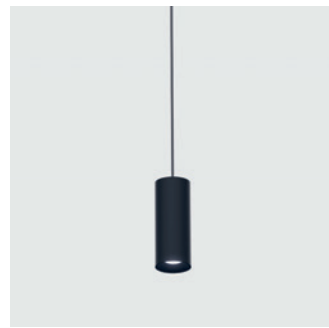

Up to
18 W

Caratteristiche illuminotecniche / Lighting specs

Watt	Watt LED	mA	IRC/CRI	CCTs	Nom lm	Del lm
12	11.8	350	>90	2700K	1539	1179
				3000K	1618	1239
				4000K	1700	1302
18	17.4	500	>90	2700K	2124	1627
				3000K	2235	1712
				4000K	2347	1798

Codice base Base code	Temperatura Temperature	Potenza Power	Fascio Beam	Finitura Finishing	Alimentazione Driver
2040	Z 2700K	B 12W	B 12°	1 Bianco White	E On-Off
	7 3000K	C 18W	F 24°	L DALI	
	8 4000K		M 38°	2 Nero Black	C Casambi
			T 60°		

* A richiesta è possibile configurare il prodotto con LED speciali e temperature colore dedicate.
Special LEDs and specific colour temperatures can be configured on request.

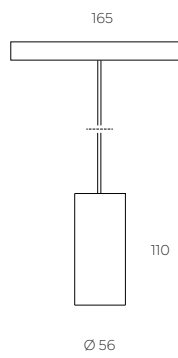

0,5 Kg

- Bianco
White
- Nero
Black
- Finiture custom
Custom finishes

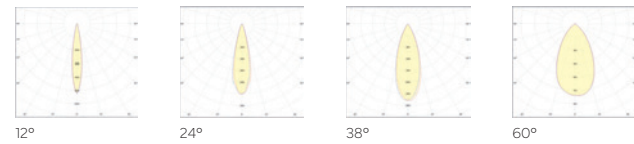

P20 48 V CV RG1 Warranty up to 5 years

Magic Ice



2 W

Caratteristiche illuminotecniche / Lighting specs

Watt	Watt LED	mA	IRC/CRI	CCTs	Nom lm	Del lm
2	1.7	350	>90	2700K	195	162
				3000K	195	162
				3500K	195	162
				4000K	195	162

Codice base Base code	Temperatura Temperature	Potenza Power	Fascio Beam	Finitura Finishing	Alimentazione Driver
1148	Z 2700K	B 2W	G 25°	1 Bianco White	E On-Off
	7 3000K		N 40°	L DALI	
	0 3500K		T 60°	2 Nero Black	
	8 4000K		1 80°		

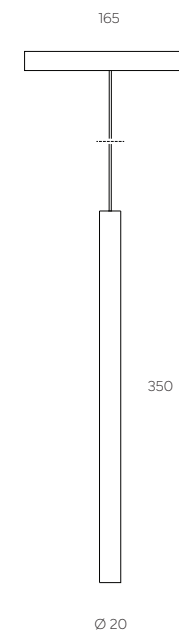

0,3 Kg

- Bianco
White
- Nero
Black
- Finiture custom
Custom finishes

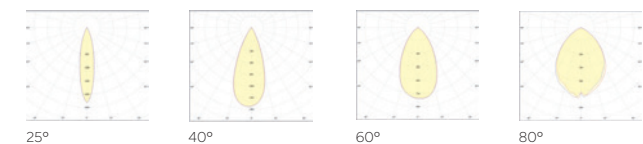

P20 48 V CV RG1 Warranty up to 5 years

Accessori / Accessories

Frangiluce
Honeycomb

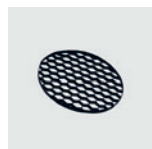

Magic K/XS KSGRI

Lenti
Lenses

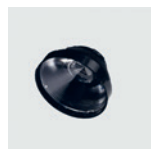

Magic K/XS

- 12° 202512
- 24° 202524
- 38° 202538
- 60° 202560



Magic linear

Magic Linear rappresenta una soluzione avanzata per l'illuminazione lineare su binario. Integrando l'effetto spot creato dai proiettori, aggiunge dinamicità ai sistemi Magic48. Questa versatile gamma di prodotti, disponibile in diverse lunghezze e composta da versioni opal e darklight, consente di creare progetti luminosi con molteplici effetti visivi, contribuendo così a valorizzare gli spazi illuminati in modo elegante e funzionale.

Magic Linear provides advanced solutions for linear track lighting. By complementing the spot effect created by the spotlights, it adds dynamism to Magic48 systems. This versatile product range is available in different lengths and includes opal and darklight versions. It enables the creation of lighting designs with multiple visual effects, enhancing illuminated spaces in an elegant and functional way.



Magic Linear Opal



Up to 23.5W

Caratteristiche illuminotecniche / Lighting specs

Watt	Watt LED	mA	IRC/CRI	CCTs	Nom lm	Del lm
6	5.5	500	>90	2700K	550	360
				3000K	560	365
				4000K	580	380
12	11	500	>90	2700K	1020	663
				3000K	1060	690
				4000K	1100	715
23.5	22	500	>90	2700K	2080	1360
				3000K	2120	1380
				4000K	2210	1435

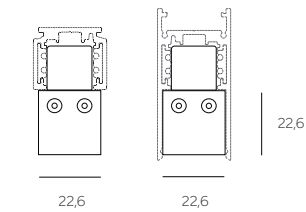

M 286 / L 566 / XL 1126 mm
0,2 - 0,7 Kg

Bianco White
Nero Black

Codice base Base code	Potenza Power	Temperatura Temperature	Fascio Beam	Finitura Finishing	Alimentazione Driver
JA48O	M 6W	Z 2700K	Z Diffuse	1 Bianco White	E On-Off
	L 12W	7 3000K		2 Nero Black	L DALI
	XL 23.5W	8 4000K		C Casambi	

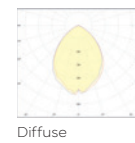

P20 48 V CV RG1 CE T_a 25 °C 5 years Warranty up to

Magic Linear Excel UGR<19



Up to 35 W

Caratteristiche illuminotecniche / Lighting specs

Watt	Watt LED	mA	IRC/CRI	CCTs	Nom lm	Del lm
9	8.4	450	>90	2700K	1057	823
				3000K	1057	823
				4000K	1057	823
18	16.8	450	>90	2700K	2114	1646
				3000K	2114	1646
				4000K	2114	1646
35	33.6	450	>90	2700K	4228	3292
				3000K	4228	3292
				4000K	4228	3292

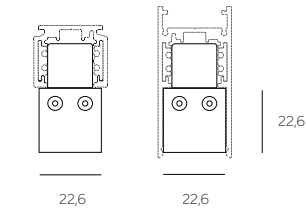

S 146 / M 286 / L 566 mm
0,1 - 0,4 Kg

Bianco White
Nero Black

Codice base Base code	Potenza Power	Temperatura Temperature	Fascio Beam	Finitura Finishing	Alimentazione Driver
JA48E	S 9W	Z 2700K	C 15° K 30° R 50°	1 Bianco White	E On-Off
	M 18W	7 3000K		2 Nero Black	L DALI
	L 35W	8 4000K		C Casambi	

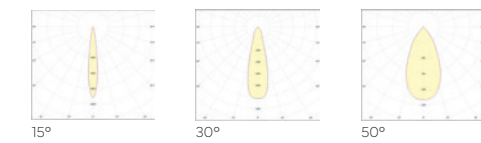

P20 48 V CV UGR <19 RG1 CE T_a 25 °C 5 years Warranty up to

Magic Linear Microprismatic UGR<19



Up to 23.5W

Caratteristiche illuminotecniche / Lighting specs

Watt	Watt LED	mA	IRC/CRI	CCTs	Nom lm	Del lm
6	5.5	500	>90	2700K	550	467
				3000K	560	476
				4000K	580	493
12	11	500	>90	2700K	1020	867
				3000K	1060	901
				4000K	1100	935
23.5	22	500	>90	2700K	2080	1768
				3000K	2120	1802
				4000K	2210	1878

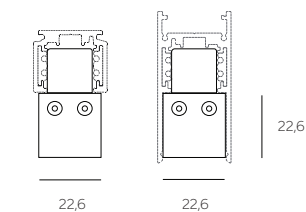

M 286 / L 566 / XL 1126 mm
0,2 - 0,7 Kg

Bianco White
Nero Black

Codice base Base code	Potenza Power	Temperatura Temperature	Fascio Beam	Finitura Finishing	Alimentazione Driver
JA48T	M 6W	Z 2700K	Z Diffuse	1 Bianco White	E On-Off
	L 12W	7 3000K		2 Nero Black	L DALI
	XL 23.5W	8 4000K		C Casambi	

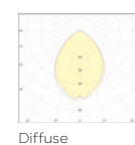

220/240V - 50/60Hz
P20 48 V CV UGR <19 RG1 CE T_a 25 °C 5 years Warranty up to

Magic Linear Front Opal



Up to 28.8W

Caratteristiche illuminotecniche / Lighting specs

Watt	Watt LED	mA	IRC/CRI	CCTs	Nom lm	Del lm
6.1	5.3	500	>90	2700K	710	495
				3000K	710	495
				4000K	710	495
11.4	10.6	500	>90	2700K	1420	990
				3000K	1420	990
				4000K	1420	990
17.2	15.9	500	>90	2700K	2129	1485
				3000K	2129	1485
				4000K	2129	1485
22.9	21.2	500	>90	2700K	2839	1980
				3000K	2839	1980
				4000K	2839	1980
28.8	26.5	500	>90	2700K	3549	2475
				3000K	3549	2475
				4000K	3549	2475

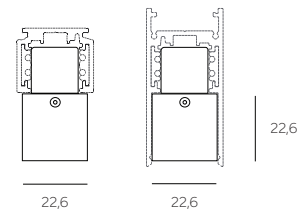

286 / 567 / 847 / 1128 / 1408 mm
0,2 - 0,9 Kg

Bianco White
Nero Black

Codice base Base code	Temperatura Temperature	Potenza Power	Fascio Beam	Finitura Finishing	Alimentazione Driver
9870 286 mm	Z 2700K	D 48V	Z Diffuso	1 Bianco White	E On-Off
9871 567 mm	7 3000K			2 Nero Black	L DALI
9872 847 mm	8 4000K				
9873 1128 mm					
9874 1408 mm					

P20 48 V CV RG1 CE Ta 25 °C 5 years Warranty up to



Magic Linear Front Lens



Up to 21.2W

Caratteristiche illuminotecniche / Lighting specs

Watt	Watt LED	mA	IRC/CRI	CCTs	Nom lm	Del lm
5.7	4.2	500	>90	2700K	504	414
				3000K	504	414
				4000K	504	414
10.6	8.4	500	>90	2700K	1009	828
				3000K	1009	828
				4000K	1009	828
16.1	12.6	500	>90	2700K	1513	1242
				3000K	1513	1242
				4000K	1513	1242
21.2	16.8	500	>90	2700K	2017	1655
				3000K	2017	1655
				4000K	2017	1655

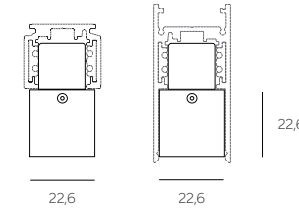

286 / 567 / 847 / 1128 mm
0,2 - 0,9 Kg

Bianco White
Nero Black

Codice base Base code	Temperatura Temperature	Potenza Power	Fascio Beam	Finitura Finishing	Alimentazione Driver
9865 286 mm	Z 2700K	D 48V	E 20°	1 Bianco White	E On-Off
9866 567 mm	7 3000K		K 30°	L DALI	
9867 847 mm	8 4000K		O 26x42°	2 Nero Black	
9868 1128 mm					

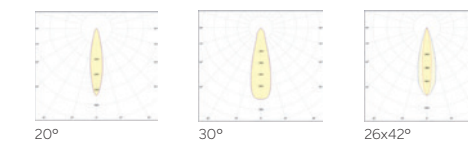

P20 48 V CV RG1 CE Ta 25 °C 5 years Warranty up to

Magic Linear Front UGR<19

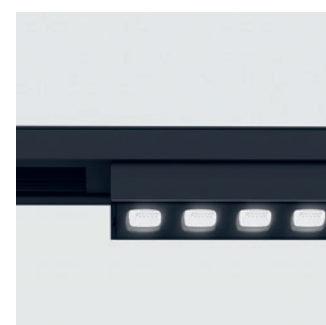

Up to 21.2W

Caratteristiche illuminotecniche / Lighting specs

Watt	Watt LED	mA	IRC/CRI	CCTs	Nom lm	Del lm
5.7	4.2	500	>90	2700K	504	413
				3000K	504	413
				4000K	504	413
10.6	8.4	500	>90	2700K	1009	826
				3000K	1009	826
				4000K	1009	826
16.1	12.6	500	>90	2700K	1513	1239
				3000K	1513	1239
				4000K	1513	1239
21.2	16.8	500	>90	2700K	2017	1652
				3000K	2017	1652
				4000K	2017	1652

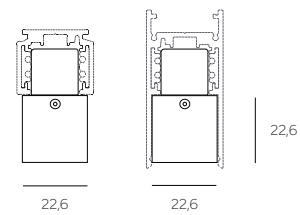

286 / 567 / 847 / 1128 mm
0,2 - 0,7 Kg

Bianco White
Nero Black

Codice base Base code	Temperatura Temperature	Potenza Power	Fascio Beam	Finitura Finishing	Alimentazione Driver
9875 286 mm	Z 2700K	D 48V	P 45°	1 Bianco White	E On-Off
9876 567 mm	7 3000K			2 Nero Black	L DALI
9877 847 mm	8 4000K				
9878 1128 mm					

P20 48 V CV UGR <19 RG1 CE Ta 25 °C 5 years Warranty up to

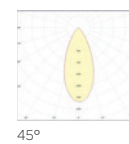

Magic Linear Flat Opal



Up to
25,5W

Caratteristiche illuminotecniche / Lighting specs

Watt	Watt LED	mA	IRC/CRI	CCTs	Nom lm	Del lm
9	8	250	>90	2700K	1106	567
				3000K	1106	567
				4000K	1106	567
17,5	16,5	500	>90	2700K	2212	1133
				3000K	2212	1133
				4000K	2212	1133
25,5	24,5	750	>90	2700K	3320	1700
				3000K	3320	1700
				4000K	3320	1700

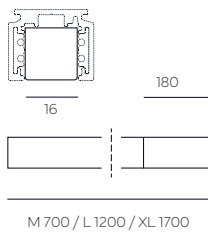

0,3 - 0,9 Kg

- Bianco
White
- Nero
Black

Codice base Base code	Potenza Power	Temperatura Temperature	Fascio Beam	Finitura Finishing	Alimentazione Driver
ST480	M 9W	Z 2700K	Z Diffuse	1 Bianco White	E On/Off
	L 16,5W	7 3000K		2 Nero Black	L DALI
	XL 24,5W	8 4000K			

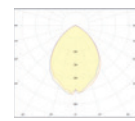

Diffuse

P20

48 V
CV
RG1
CE
T_a
25 °C
5 years

Magic Linear Flat Lens

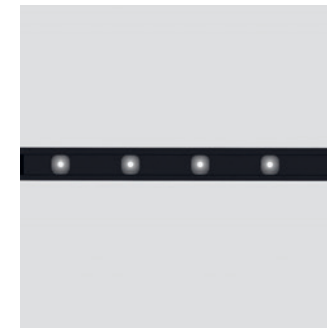

5 W

Caratteristiche illuminotecniche / Lighting specs

Watt	Watt LED	mA	IRC/CRI	CCTs	Nom lm	Del lm
5	4,3	300	>90	2700K	494	305
				3000K	494	305
				4000K	494	305

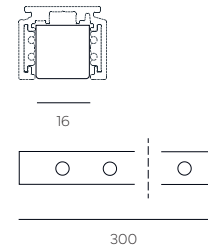

0,2 Kg

- Bianco
White
- Nero
Black

Codice base Base code	Potenza Power	Temperatura Temperature	Fascio Beam	Finitura Finishing	Alimentazione Driver
ST48L	M 5W	Z 2700K	K 30°	1 Bianco White	L DALI
		7 3000K		2 Nero Black	
		8 4000K			

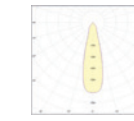

30°

P20

48 V
CV
RG1
CE
T_a
25 °C
5 years

Magic Linear Flat Excel UGR<19

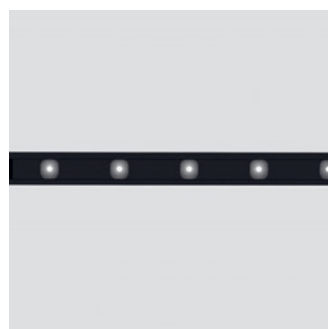

5 W

Caratteristiche illuminotecniche / Lighting specs

Watt	Watt LED	mA	IRC/CRI	CCTs	Nom lm	Del lm
5	4,3	300	>90	2700K	494	320
				3000K	494	320
				4000K	494	320

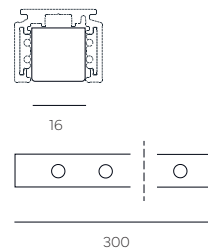

0,2 Kg

- Bianco
White
- Nero
Black

Codice base Base code	Potenza Power	Temperatura Temperature	Fascio Beam	Finitura Finishing	Alimentazione Driver
ST48E	M 5W	Z 2700K	T 60°	1 Bianco White	L DALI
		7 3000K		2 Nero Black	
		8 4000K			

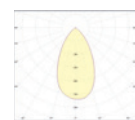

60°

P20

48 V
CV
UGR
<19
RG1
CE
T_a
25 °C
5 years



Micro48

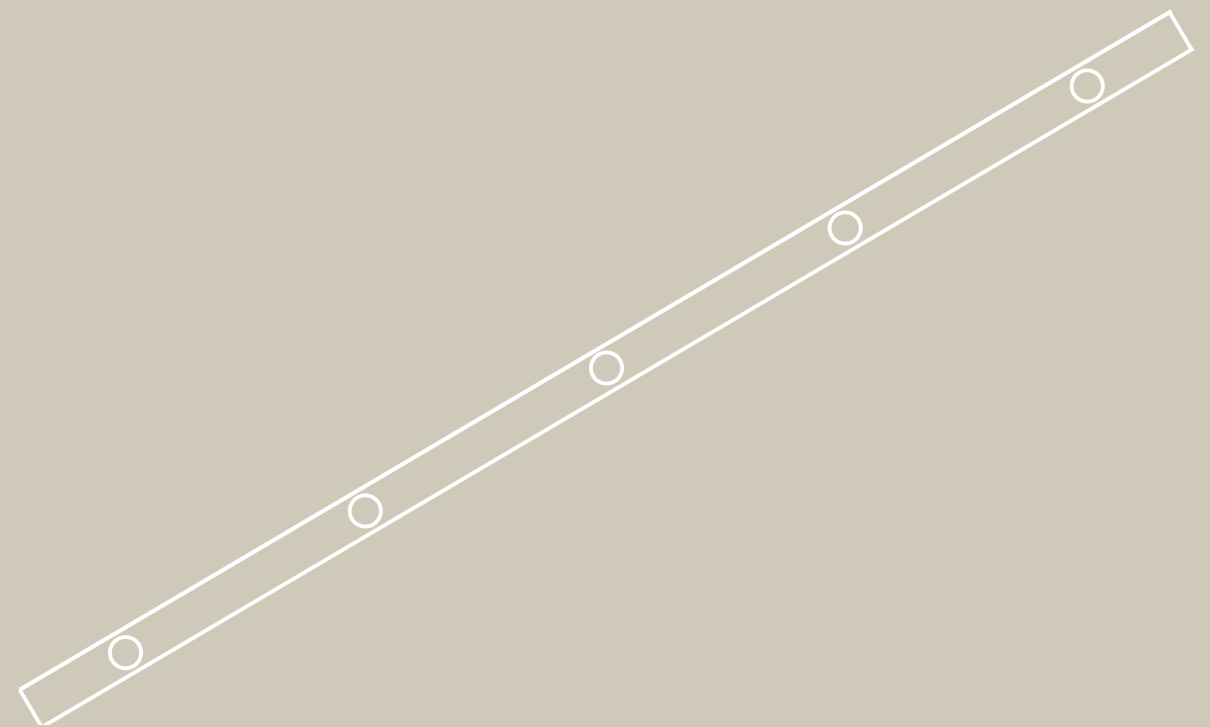

Micro tracks 48V

8630
Standard
Surface

8650
Recessed
Trimless

8635
Deep
Surface

8635
Deep
Suspended





Surface

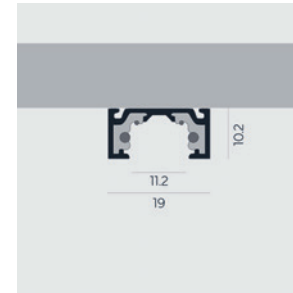

Micro48 Standard - 8630

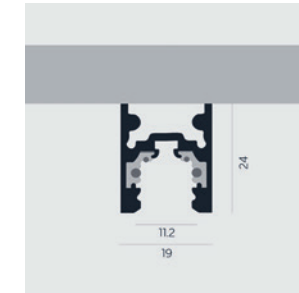

Micro48 Deep - 8635

Recessed

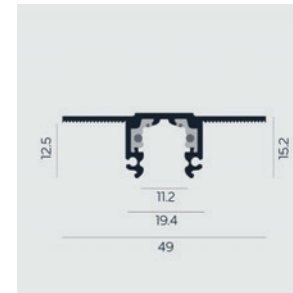

Micro48 trimless - 8650

Suspended

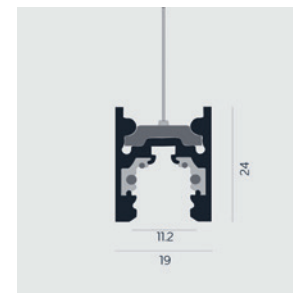

Micro48 Deep - 8650

Micro48 Standard - 8630

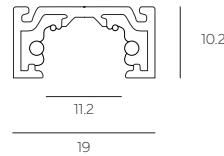

Codice base Base code	Lunghezza mm Length mm	Colore Finishes	Peso Kg Weight Kg
8630	A01 1000	1 Bianco / White	0.7
	A02 2000	2 Nero / Black	1.4
	A03 3000		2.1

Binario elettrificato in estruso di alluminio a bassa tensione per installazione a superficie
Low voltage electrified extruded aluminium track for surface installation



Micro48 Deep - 8635

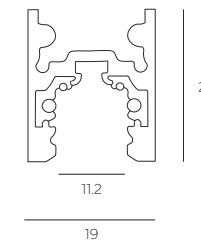

Codice base Base code	Lunghezza mm Length mm	Colore Finishes	Peso Kg Weight Kg
8635	A01 1000	1 Bianco / White	0.9
	A02 2000	2 Nero / Black	1.8
	A03 3000		2.7

Binario elettrificato in estruso di alluminio a bassa tensione per installazione a sospensione. Con possibilità di luce indiretta.
Low voltage electrified extruded aluminium track for suspended installation. Indirect light available on request



Accessori / Accessories

	Tappo di chiusura / End cap	<input type="checkbox"/>	<input type="checkbox"/>	8630A131	8630A132
	Cover estetica (3 mt) / Aesthetic cover (3mt)	<input type="checkbox"/>	<input type="checkbox"/>	8630A1731	8630A1732
	Rosone per driver (drive non incluso) / Driver box (driver not included)	<input type="checkbox"/>	<input type="checkbox"/>	9630E151	9630E152
	Giunto angolare meccanico (soffitto-soffitto) / Angular mechanical joint (ceiling-ceiling)	<input type="checkbox"/>	<input type="checkbox"/>	8630A281	8630A282
	Giunto angolare meccanico (parete-soffitto) / Angular mechanical joint (wall-ceiling)	<input type="checkbox"/>	<input type="checkbox"/>	8630A291	8630A292
	*Binario curvo R0.5 mt (soffitto-soffitto) / Curved track R0.5 mt (ceiling-ceiling)	<input type="checkbox"/>	<input type="checkbox"/>	8630AC51	8630AC52
	*Binario curvo R0.3 mt (parete-soffitto) / Curved track R0.3 mt (wall-ceiling)	<input type="checkbox"/>	<input type="checkbox"/>	8630AV31	8630AV32

NB: La curve hanno solo funzione estetica e di collegamento elettrico, gli adattatori non sono installabili
NB: The curves have aesthetic and electrical connection function only, the adapters cannot be installed

* Dimensioni, raggio e percorso personalizzabili su richiesta / Curve radius, dimensions and shape customizable on request

Connessioni / Connections

	Testata / End feed	<input type="checkbox"/>	<input type="checkbox"/>	8630A121	8630A122
	Giunto lineare elettrico / Electric linear connector	<input type="checkbox"/>	<input type="checkbox"/>	8630A141	8630A142
	Giunto angolare elettrico / Electric angular connector	<input type="checkbox"/>	<input type="checkbox"/>	8630A231	8630A232
	Giunto flessibile elettrico / Electric flexible connector	<input type="checkbox"/>	<input type="checkbox"/>	8630A311	8630A312

Accessori / Accessories

	Tappo di chiusura / End cap	<input type="checkbox"/>	<input type="checkbox"/>	8635A131	8635A132
	Cover estetica (3 mt) / Aesthetic cover (3mt)	<input type="checkbox"/>	<input type="checkbox"/>	8630A1731	8630A1732
	Rosone per driver (drive non incluso) / Driver box (driver not included)	<input type="checkbox"/>	<input type="checkbox"/>	9630E151	9630E152
	Giunto lineare meccanico / Linear mechanical joint	<input type="checkbox"/>	<input type="checkbox"/>	8635A441	8635A442

Kit sospensione e fissaggio / Suspension kits

	Kit sospensione di regolatore e staffa / Suspension kit with gripper and bracket	<input type="checkbox"/>	<input type="checkbox"/>	2 m 8635A627	5 m 8635A657
	Rosone con cavo 5 vie L = 2 m / Ceiling rose with 5 poles cable L = 2 m	<input type="checkbox"/>	<input type="checkbox"/>	HSKITROSW	HSKITROSB

Connessioni / Connections

	Testata / End feed	<input type="checkbox"/>	<input type="checkbox"/>	8630A111	8630A112
	Giunto lineare elettrico / Electric linear connector	<input type="checkbox"/>	<input type="checkbox"/>	8630A141	8630A142
	Giunto angolare elettrico / Electric angular connector	<input type="checkbox"/>	<input type="checkbox"/>	8630A231	8630A232
	Giunto flessibile elettrico / Electric flexible connector	<input type="checkbox"/>	<input type="checkbox"/>	8630A311	8630A312

Luce indiretta / Indirect light

	Copertura opale / Opal cover	<input type="checkbox"/>	<input type="checkbox"/>	3 m 8630OPAL3		
	Strip led / LED strip	<input type="checkbox"/>	<input type="checkbox"/>	2700K SV2700	3000K SV3000	4000K SV4000

Micro48 Trimless - 8650

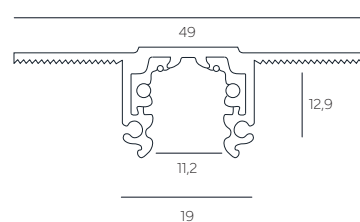

Codice base Base code	Lunghezza mm Length mm	Colore Finishes	Peso Kg Weight Kg
8650	A01 1000	2 Nero / Black	1
	A02 2000		2
	A03 3000		3

Binario elettrificato in estruso di alluminio a bassa tensione per installazione recessata trimless.
Low voltage electrified extruded aluminium track for recessed trimless installation.



Accessori / Accessories

	Tappo di chiusura / End cap		8650A132
	Cover estetica (3 mt) / Aesthetic cover (3mt)		8630A1731
			8630A1732
	Rosone per driver (drive non incluso) / Driver box (driver not included)		9630E151
			9630E152

Conessioni / Connections

	Testata / End feed		8630A122
	Giunto lineare elettrico / Electric linear connector		8630A142
	Giunto angolare elettrico / Electric angular connector		8630A232
	Giunto flessibile elettrico / Electric flexible connector		8630A312

Alimentatori 48V / 48V Drivers

Alimentatore remoto 70 W 70W Remote driver	122786	181X46X25mm
Alimentatore remoto 150W 150W Remote driver	127356	240X59X40mm
Alimentatore remoto 240W 240W Remote driver	XLG-240-H-ADI	219X63X35mm

Interfacce di controllo / Dimming interface

Ripetitore opto isolante del segnale DALI / DALI opto isolator repeater S-RP-24-48 V 180X42X29mm

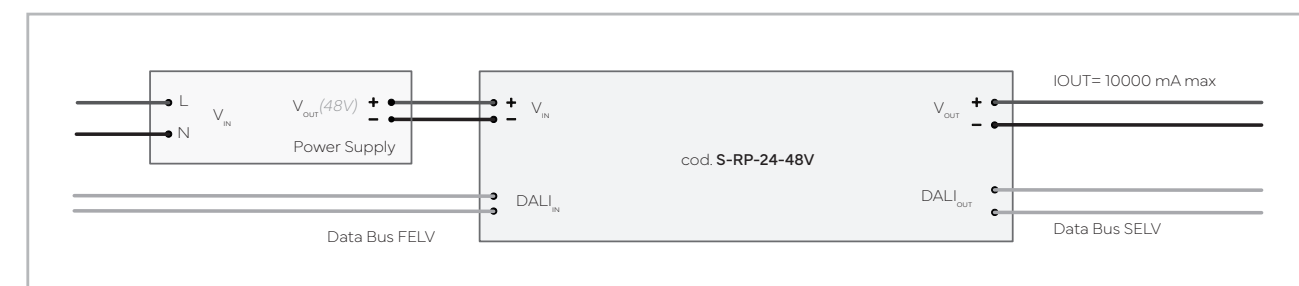

Dispositivo consigliato nel caso di utilizzo del segnale DALI, per convertirlo in segnale digitale SELV, e per protezione contro i picchi di tensione all'ingresso e in uscita. / Recommended device when using the DALI signal, to convert it into a SELV digital signal, and to protect against input and output voltage peaks.

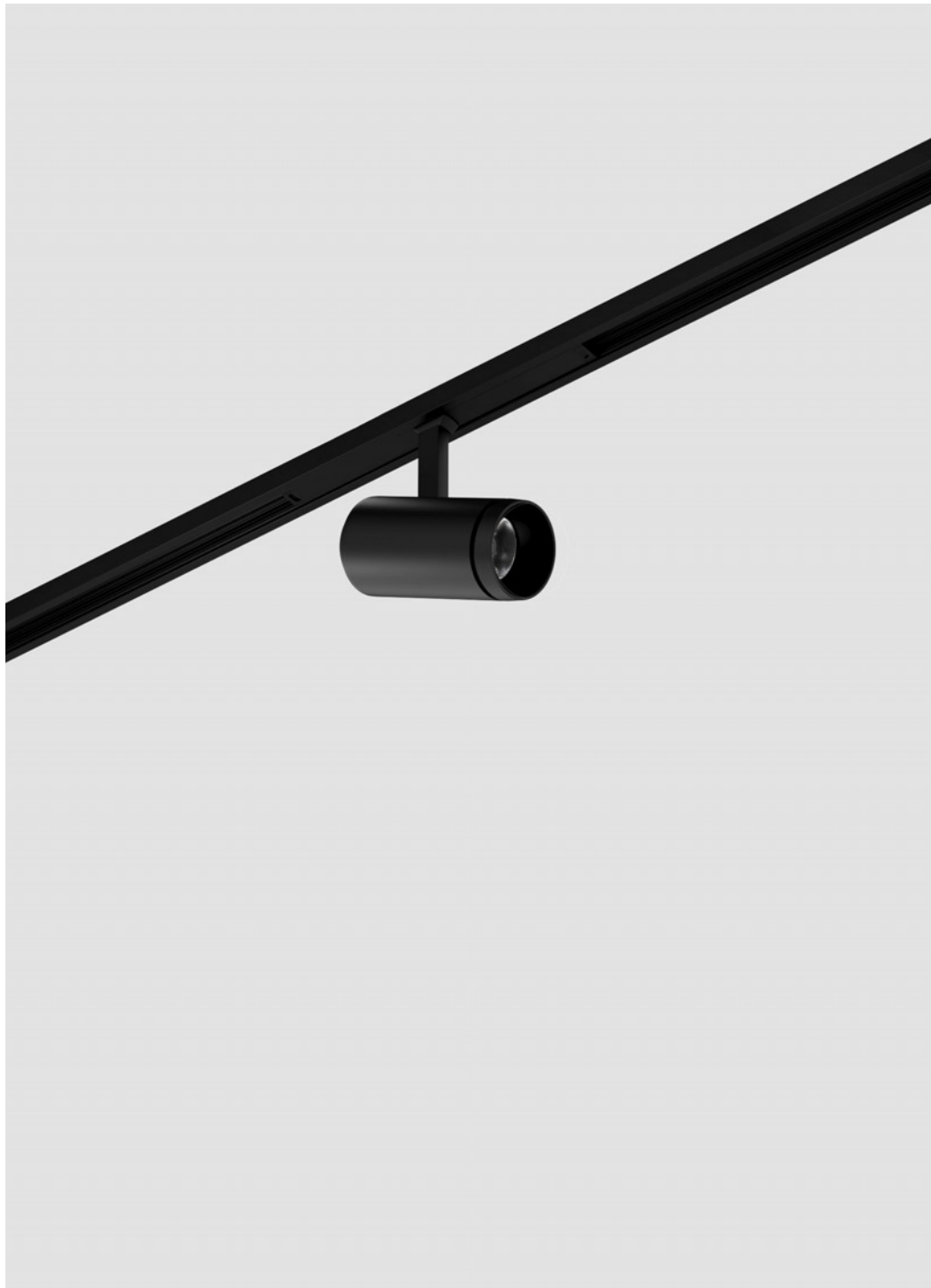

Micro Otto

Micro Otto40 è stato sviluppato per l'installazione su binari Micro48 e si distingue per il suo riflettore darklight e la sorgente luminosa particolarmente recessata. Questo proiettore unisce un design elegante a un grado di abbagliamento drasticamente ridotto. Micro Otto40 è ideale per l'illuminazione mirata e il focus su oggetti di dimensioni ridotte.

Micro Otto40 has been developed for installation on Micro48 tracks. It is characterized by its dark-light reflector and a particularly recessed light source. This spotlight combines an elegant design with a drastically reduced glare degree. Micro Otto40 is ideal for focused illumination on small objects.

Micro Otto 40



Up to 10.5W

Caratteristiche illuminotecniche / Lighting specs

Watt	Watt LED	mA	IRC/CRI	CCTs	Nom lm	Del lm
10.5	9	250	>90	2700K 3000K 4000K	986 1041 1112	790 833 889

Codice base Base code	Temperatura Temperature	Potenza Power	Fascio Beam	Finitura Finishing	Alimentazione Driver
8010	Z 2700K	A 10.5W	C 15°	1 Bianco White	E On-Off
	7 3000K		H 26°	2 Nero Black	L DALI
	8 4000K		L 36°		C Casambi
			T 60°		

* A richiesta è possibile configurare il prodotto con LED speciali e temperature colore dedicate.
Special LEDs and specific colour temperatures can be configured on request.

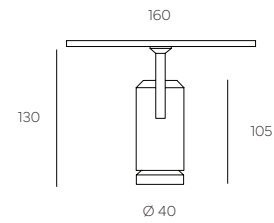
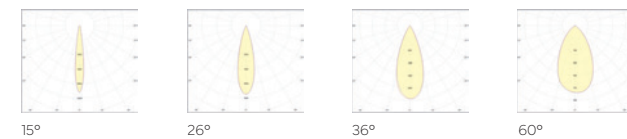

- 0,2 Kg
- Bianco
White
- Nero
Black
- Finiture custom
Custom finishes

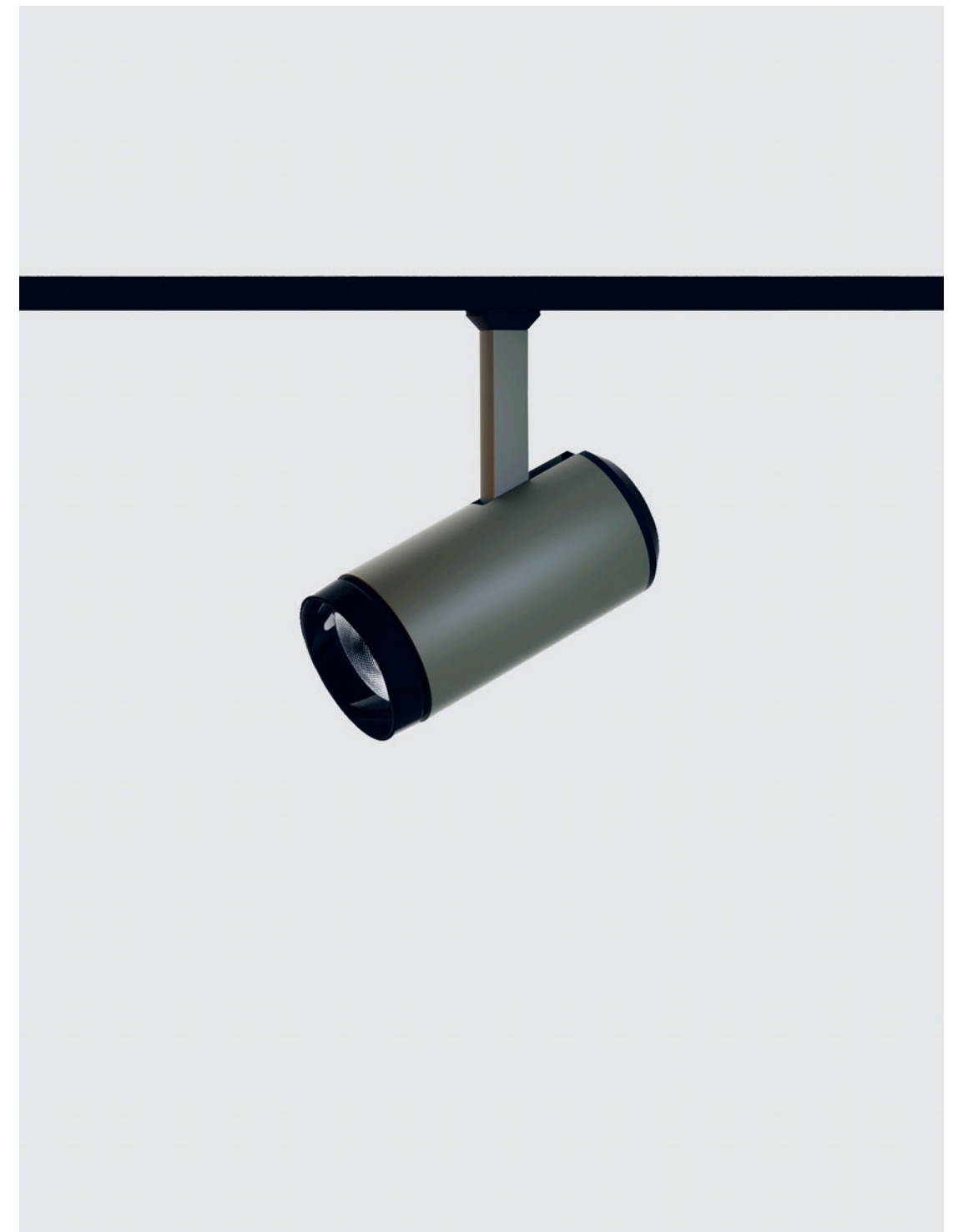

Accessori / Accessories

Kit luce di emergenza
Emergency light



- 9000B921
- 9000B922

Frangiluce alveolare
Honeycomb

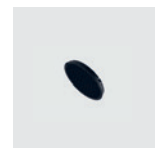

8008GR1

Frangiluce a croce
Cross-blade visor



8008CR

Filtro diffondente
Diffuse filter

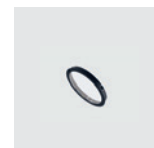

8008DI

Visore cilindrico
Cylindric visor



8008VC

Lenti
Lenses



- 15° 800815
- 26° 800826
- 36° 800836
- 60° 800860



Micro Point & Mini

I proiettori Micro Point e Micro Mini sono caratterizzati da dimensioni particolarmente compatte, essi sono progettati appositamente per incontrare le esigenze di illuminazione spotlight su binari miniaturizzati Micro48. Principalmente utilizzati per applicazioni in teche e vetrine, questi proiettori possono essere discretamente nascosti in strutture metalliche o di legno, grazie alla compattezza dell'adattatore e del corpo principale.

Micro Point and Micro Mini spotlights are characterized by their particularly compact dimensions. They are specially designed for miniaturized Micro48 tracks. Mainly used for showcases and display windows, they can be discreetly concealed in metal or wooden structures, thanks to the micro adapter and their reduced body dimensions.

Micro Point

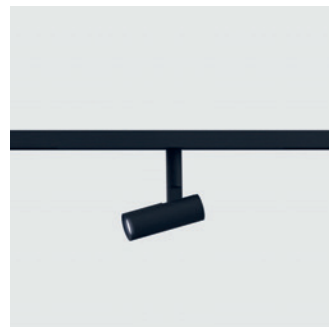

2 W

Caratteristiche illuminotecniche / Lighting specs

Watt	Watt LED	mA	IRC/CRI	CCTs	Nom lm	Del lm
2	1.7	600	>90	2700K	348	162
				3000K	348	162
				3500K	348	162
				4000K	348	162

Codice base Base code	Temperatura Temperature	Potenza Power	Fascio Beam	Finitura Finishing	Alimentazione Driver
2066	Z 2700K	Q 2W	B 25°	1 Bianco White	E On-Off
	7 3000K		D 40°	2 Nero Black	L DALI
	0 3500K		E 60°		
	8 4000K		F 80°		

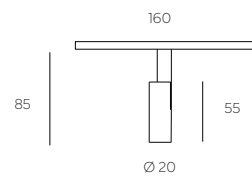

0,1 Kg

Bianco
White
Nero
Black

Finiture custom
Custom finishes

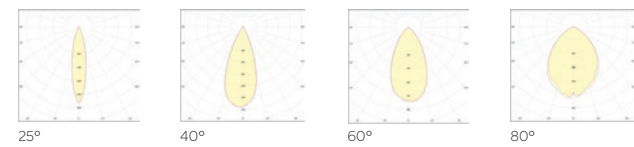

IP20, 48 V CV, RG1, CE, Ta 25 °C, 355°, 90°, Warranty up to 5 years

Micro Mini



8 W

Caratteristiche illuminotecniche / Lighting specs

Watt	Watt LED	mA	IRC/CRI	CCTs	Nom lm	Del lm
8	7	600	>90	2700K	952	762
				3000K	984	787
				4000K	1068	855

Codice base Base code	Temperatura Temperature	Potenza Power	Fascio Beam	Finitura Finishing	Alimentazione Driver
2050	Z 2700K	Q 8W	F 24°	1 Bianco White	E On-Off
	7 3000K		S 55°	2 Nero Black	L DALI
	8 4000K				C Casambi

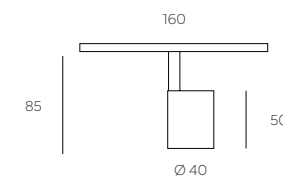

0,2 Kg

Bianco
White
Nero
Black

Finiture custom
Custom finishes

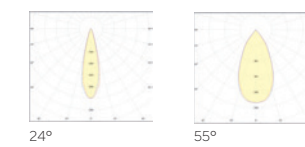

IP20, 48 V CV, RG1, CE, Ta 25 °C, 355°, 90°, Warranty up to 5 years



Micro Ice

Micro Ice è un'implementazione del progetto Ice Pendant, per integrare un elemento tecnico-decorativo a sospensione all'interno di un'installazione con binario Micro48. Questa soluzione si distingue per il basso impatto estetico ed è concepita per valorizzare superfici come banconi, reception o tavoli espositivi.

The Ice Pendant project has evolved into Micro Ice, which integrates a technical-decorative pendant element into a Micro48 track system. This solution has a low aesthetic impact and is ideal for enhancing surfaces such as bar counters, receptions or display tables.

Micro Ice

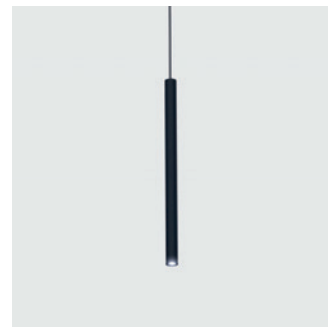

2 W

Caratteristiche illuminotecniche / Lighting specs

Watt	Watt LED	mA	IRC/CRI	CCTs	Nom lm	Del lm
2	17	350	>90	2700K	195	162
				3000K	195	162
				3500K	195	162
				4000K	195	162

Codice base Base code	Temperatura Temperature	Potenza Power	Fascio Beam	Finitura Finishing	Alimentazione Driver
1138	Z 2700K	B 2W	G 25°	1 Bianco White	E On-Off
	7 3000K		N 40°	2 Nero Black	L DALI
	0 3500K		T 60°		
	8 4000K		1 80°		

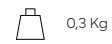
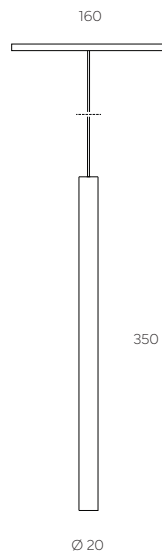

0,3 Kg



Bianco
White



Nero
Black



Finiture custom
Custom finishes

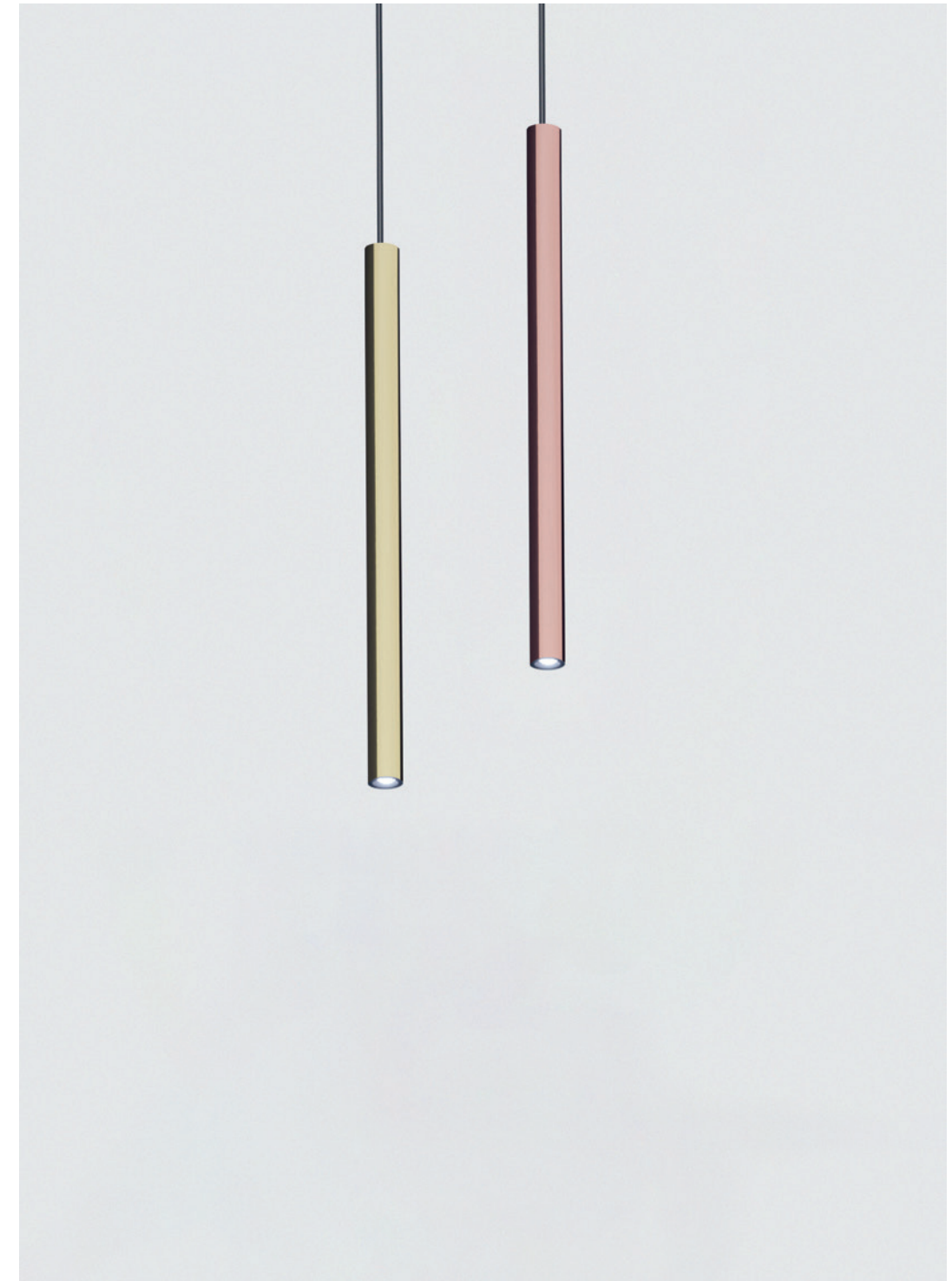
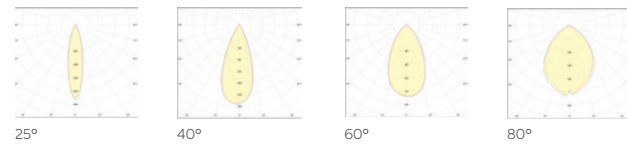



Micro linear

Micro Linear consente l'integrazione di illuminazione lineare all'interno dei sistemi Micro48, sia con effetto diffuso che con varie aperture ottiche. Dotato di una scheda LED con elettronica di controllo integrata, Micro Linear si nasconde all'interno dei binari Micro, garantendo un impatto visivo minimo.

Micro Linear allows the integration of linear lighting in Micro48 systems, either with a diffuse effect or with various optical beams. Equipped with an integrated electrical control board, Micro Linear is concealed inside the Micro tracks, ensuring a minimal visual impact.

Micro Linear Opal

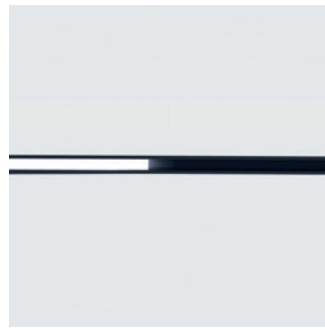

Up to 21.5W

Caratteristiche illuminotecniche / Lighting specs

Watt	Watt LED	mA	IRC/CRI	CCTs	Nom lm	Del lm
75	6.5	200	>90	2700K	900	430
				3000K	900	430
					900	430
14.5	13	400	>90	2700K	1800	860
				3000K	1800	860
					1800	860
21.5	19	600	>90	2700K	2700	1290
				3000K	2700	1290
					2700	1290

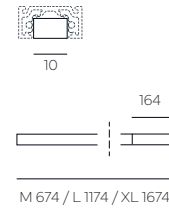

0,1 - 0,5 Kg

Nero
Black

Codice base Base code	Potenza Power	Temperatura Temperature	Fascio Beam	Finitura Finishing	Alimentazione Driver
SM48O	M 7.5W	Z 2700K	Z Diffuse	2 Nero Black	L DALI
	L 14.5W	7 3000K			
	XL 21.5W				

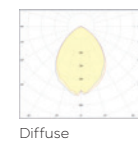

Diffuse

P20 48V CV RG1 CE T_a 25 °C 5 years Warranty up to

Micro Linear Lens



5 W

Caratteristiche illuminotecniche / Lighting specs

Watt	Watt LED	mA	IRC/CRI	CCTs	Nom lm	Del lm
5	4.3	300	>90	2700K	440	317
				3000K	440	317
					440	317

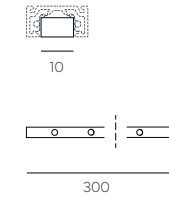

0,1 Kg

Nero
Black

Codice base Base code	Potenza Power	Temperatura Temperature	Fascio Beam	Finitura Finishing	Alimentazione Driver
SM48L	M 5W	Z 2700K	K 30°	2 Nero Black	L DALI
		7 3000K			

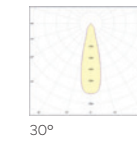

30°

P20 48V CV RG1 CE T_a 25 °C 5 years Warranty up to

Micro Linear Excel UGR<19



5 W

Caratteristiche illuminotecniche / Lighting specs

Watt	Watt LED	mA	IRC/CRI	CCTs	Nom lm	Del lm
5	4.3	300	>90	2700K	440	385
				3000K	440	385
					440	385

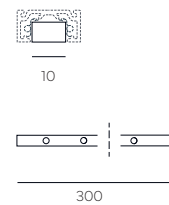

0,1 Kg

Bianco
White
Nero
Black

Codice base Base code	Potenza Power	Temperatura Temperature	Fascio Beam	Finitura Finishing	Alimentazione Driver
SM48E	M 5W	Z 2700K	T 60°	1 Bianco White	L DALI
		7 3000K		2 Nero Black	
		8 4000K			

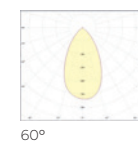

60°

P20 48V CV UGR <19 RG1 CE T_a 25 °C 5 years Warranty up to



Omnia

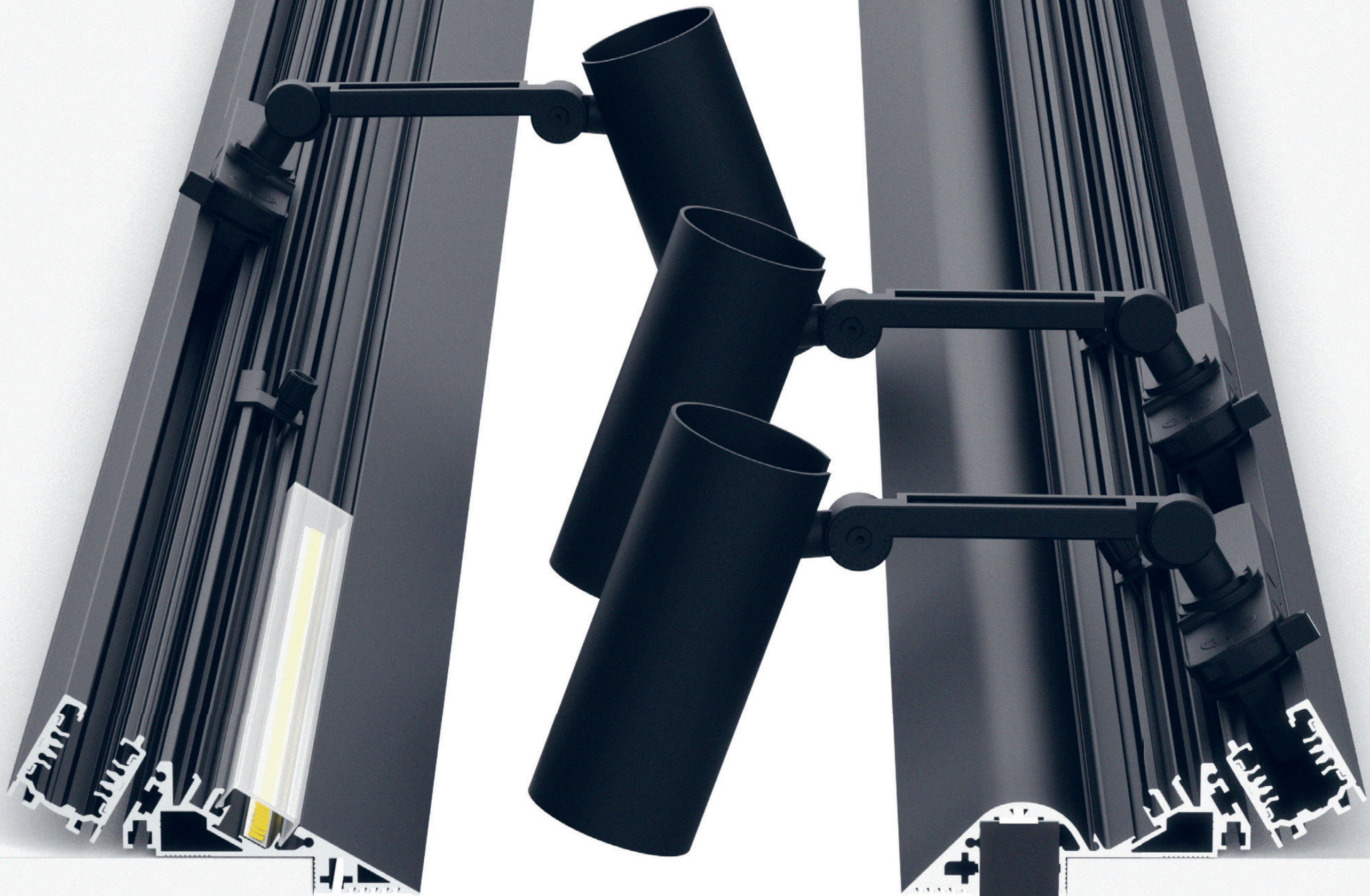

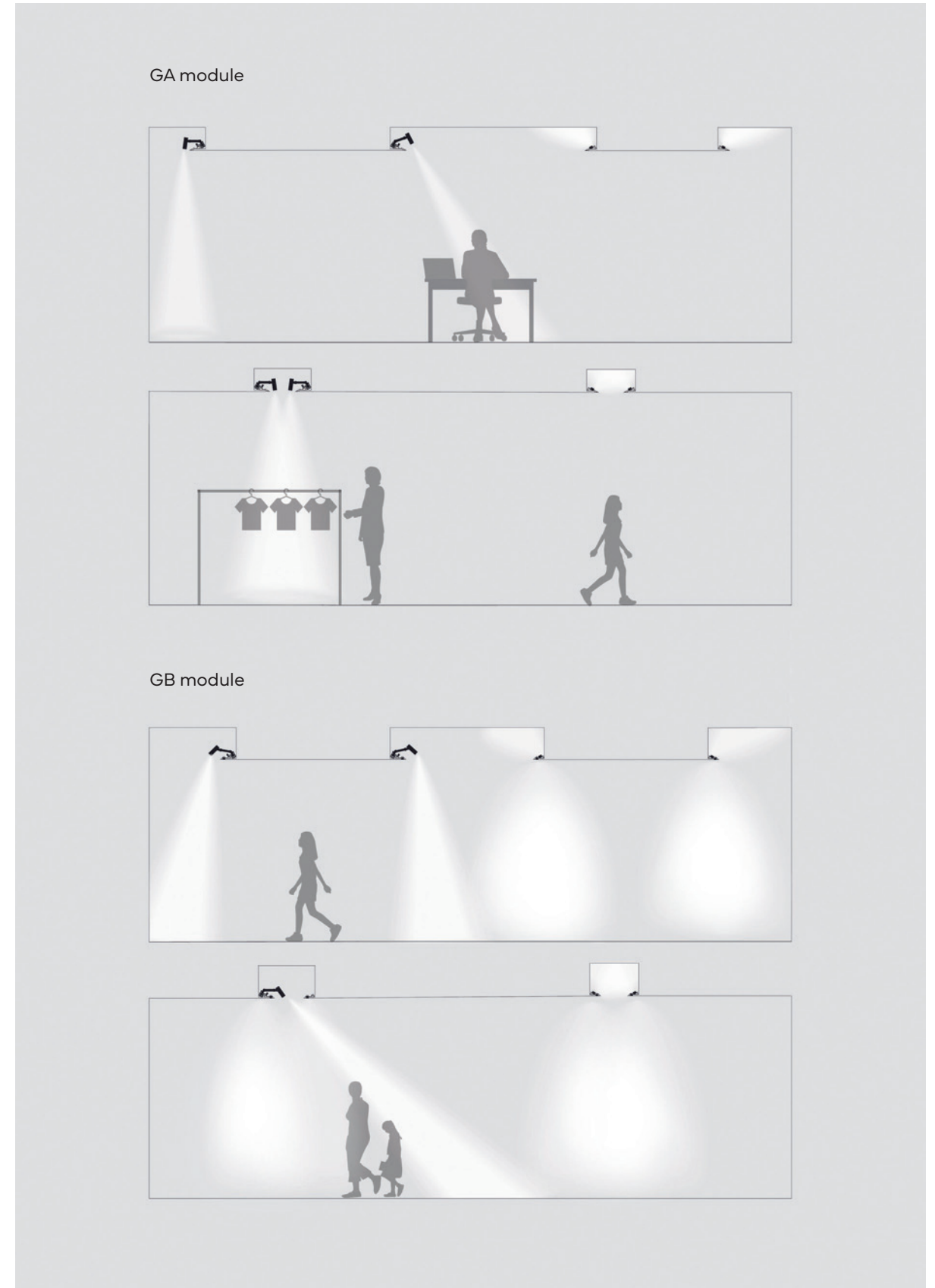
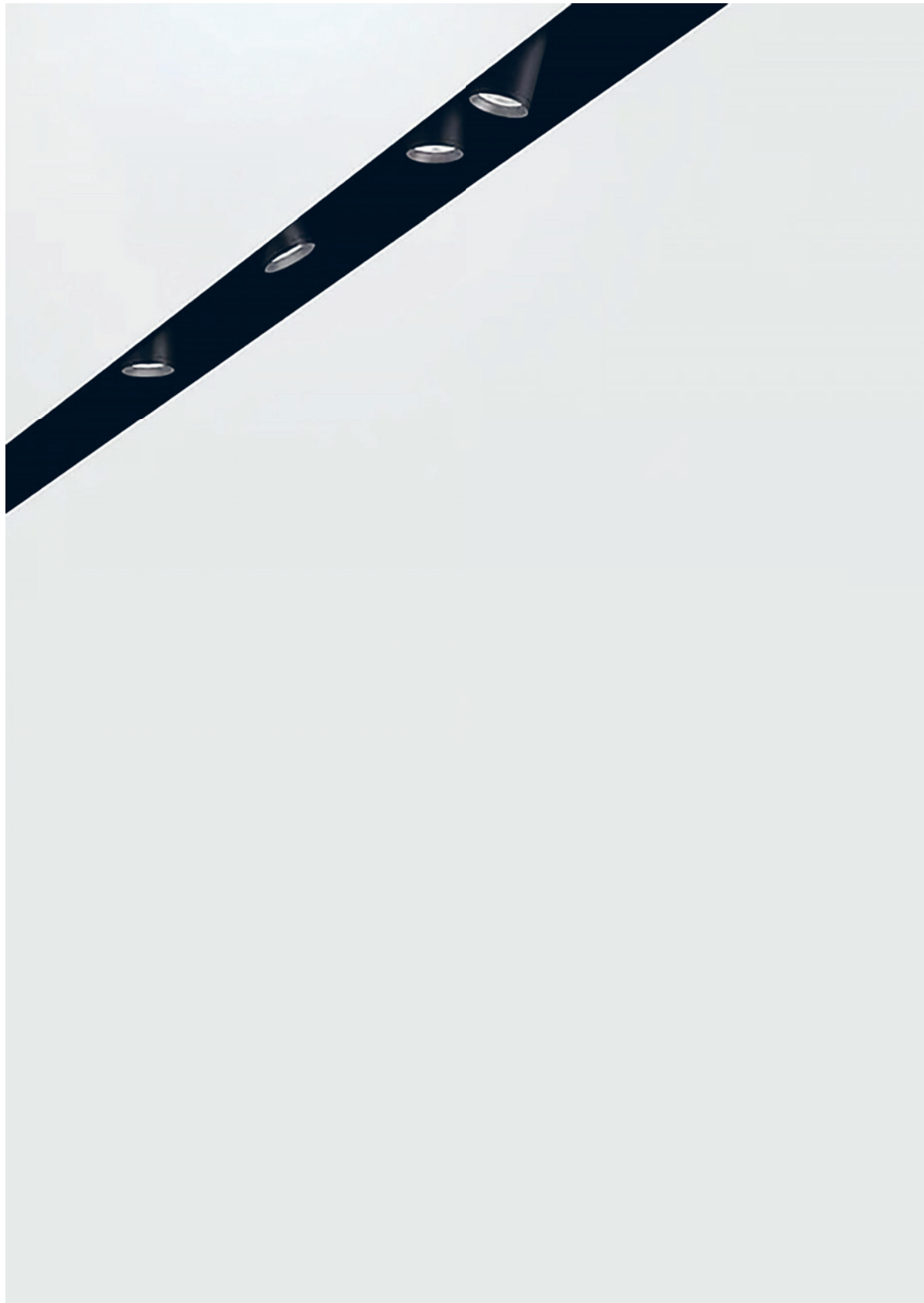

Omnia system

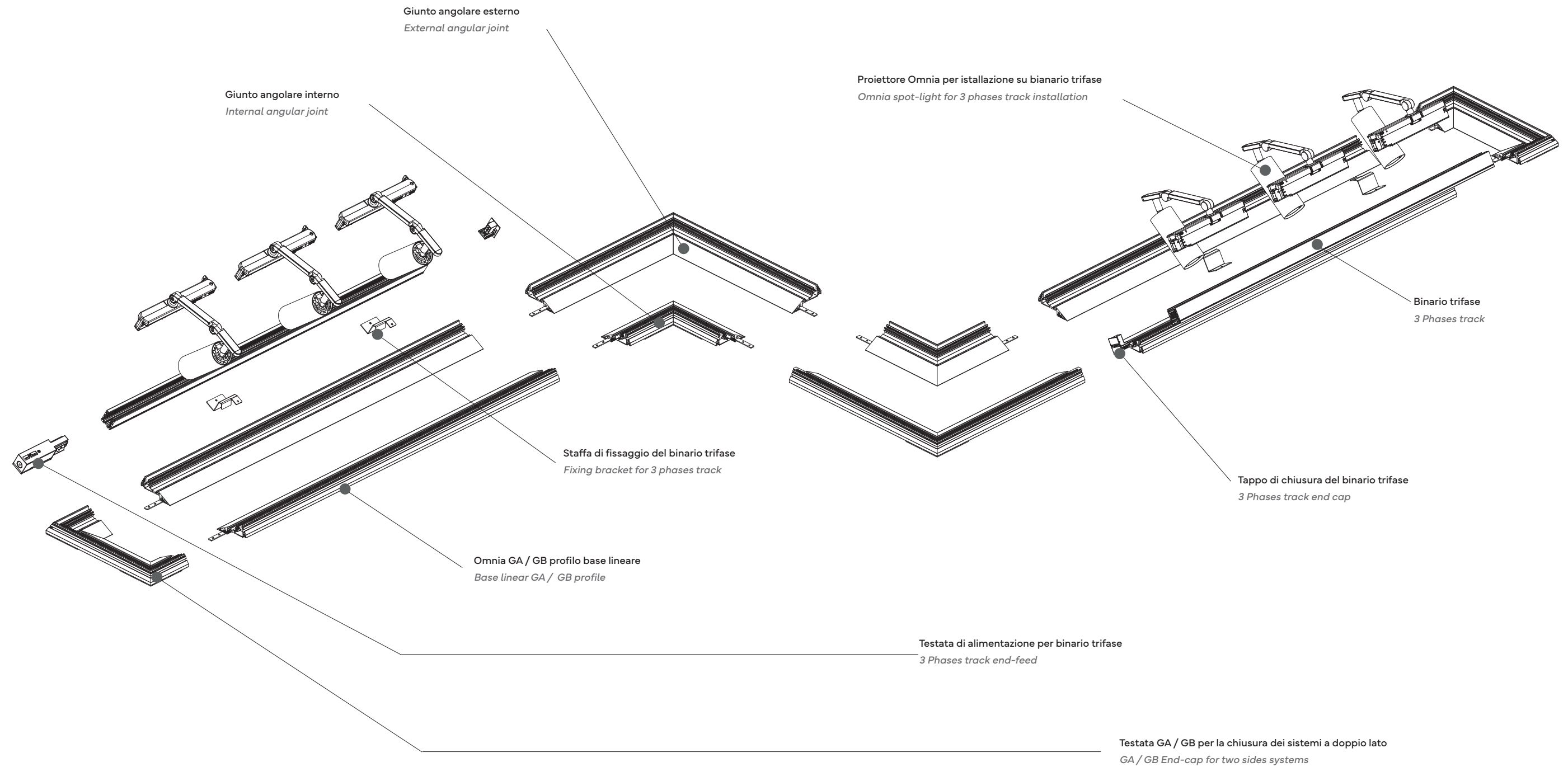

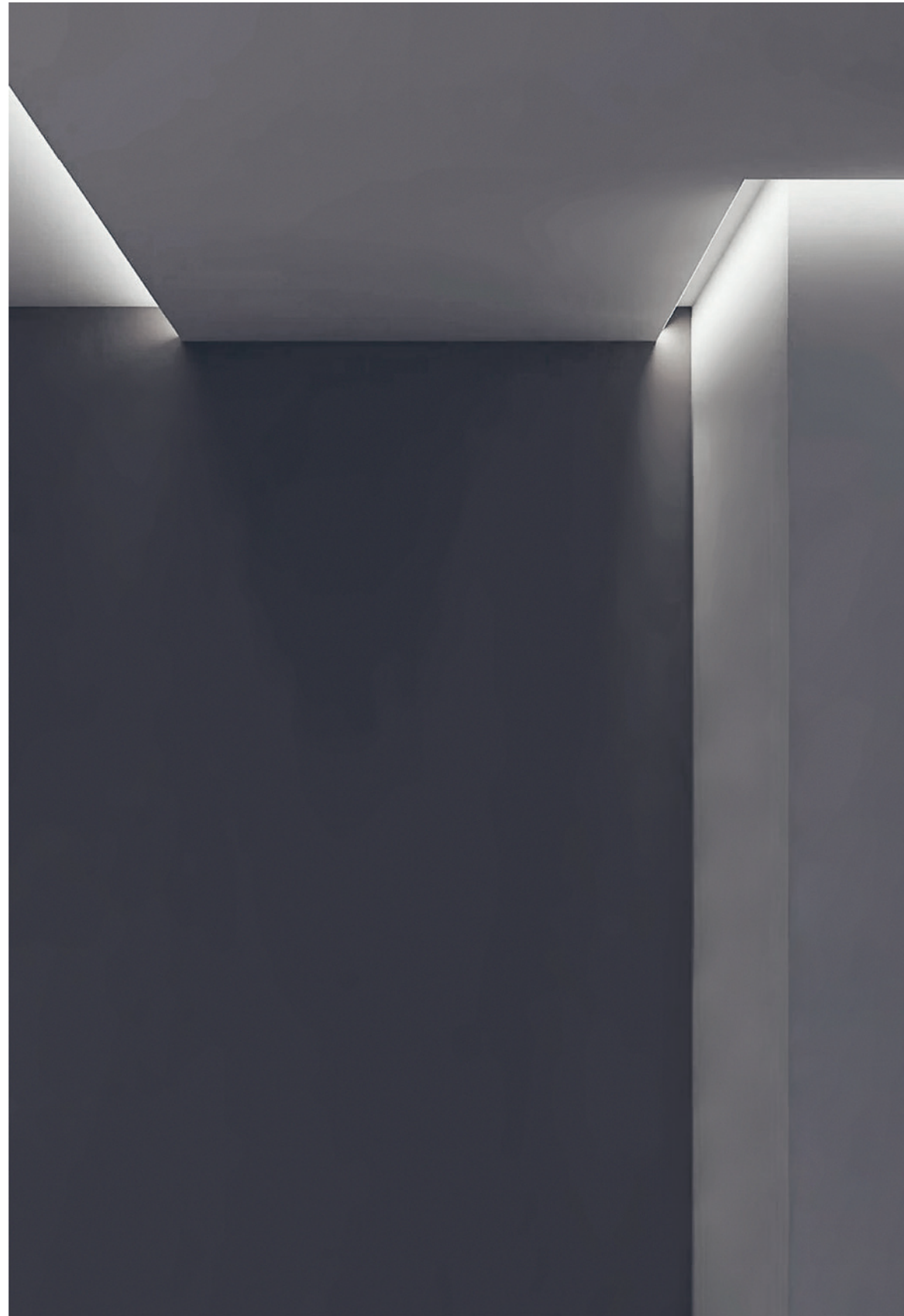

Omnia GA

Omnia GA è un sistema di estrusi modulari appositamente progettati per la realizzazione di installazioni a gola. La versione GA è completa di molteplici accessori che consentono di soddisfare svariate esigenze nel design dell'illuminazione. Il sistema permette l'installazione di proiettori orientabili e di illuminazione a luce indiretta.

Omnia GA is a modular system made of extruded aluminum, specifically designed for cove lighting applications. It comes with multiple accessories to meet various lighting design requirements. The system allows the installation of adjustable spotlights and indirect lighting.

Predisposizione per il fissaggio del binario trifase e dei proiettori
Predisposition for three-phases track and spotlight installation

Predisposizione per l'installazione di cover diffondente o microprismata
Predisposition for diffuse or microprismatic cover installation

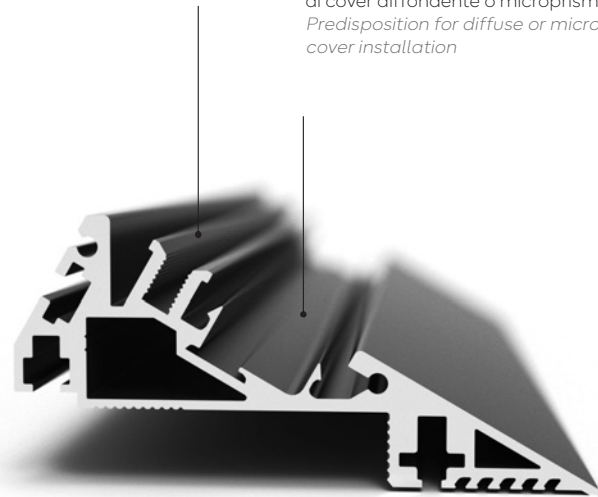

GA module

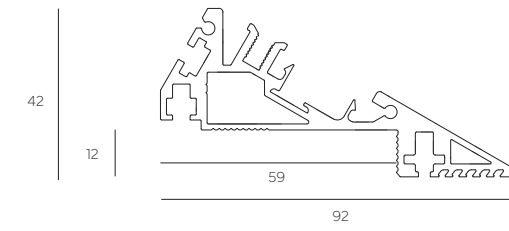

Codice base Base code	Lunghezza mm Length mm	Colore Finishes	Peso Kg Weight Kg
GA	100	B Bianco / White	1.6
	200	W Nero / Black	3.2
	300		4.8

Profilo in alluminio dedicato alla creazione di sistemi di gole luminose. Predisposto per luce indiretta e spot.
Aluminum profile for cove lighting systems. This system is available with indirect light and spot lights.

Accessori di installazione / Installation Accessories

	Giunto lineare / Linear joint	<input type="checkbox"/> GAJNTA	<input type="checkbox"/>		Staffa per fissaggio su struttura / Structure fixing bracket	<input type="checkbox"/> GASTRW	<input checked="" type="checkbox"/> GASTRB
	Giunto Angolare / Angular Joint	<input type="checkbox"/> GAJ90A	<input type="checkbox"/>		Staffa per binario main voltage / Main voltage track bracket	<input type="checkbox"/> GATRKW	<input checked="" type="checkbox"/> GATRKB
	Staffa per Sospensione / Suspension bracket	<input type="checkbox"/> GAPENW	<input checked="" type="checkbox"/> GAPENB		Giunto angolare interno / System inner angular joint	<input type="checkbox"/> GAI90W	<input checked="" type="checkbox"/> GAI90B
	Chiusura finale per sistemi a doppio lato / Two sided system end-cap	<input type="checkbox"/> GAENDW	<input checked="" type="checkbox"/> GAENDB		Giunto angolare esterno / System outer angular joint	<input type="checkbox"/> GAE90W	<input checked="" type="checkbox"/> GAE90B

Binario Trifase / Main Voltage Track



Codice base Base code	Lunghezza mm Length mm	Colore Finishes	Peso Kg Weight Kg
9605	A01	1 Bianco / White	1.05 kg
	A02	2 Nero / Blac	2.04 kg
	A03	0 Grigio / Gray	3.06 kg

	Testata polarità destra / Right polarity end-feed	<input type="checkbox"/> 9605A121	<input checked="" type="checkbox"/> 9605A122		Testata centrale / Middle feed connector	<input type="checkbox"/> 9605A261	<input checked="" type="checkbox"/> 9605A262
	Testata polarità sinistra / Left polarity end-feed	<input type="checkbox"/> 9605A151	<input checked="" type="checkbox"/> 9605A152		Giunto flessibile / Flexible connector	<input type="checkbox"/> 9605A161	<input checked="" type="checkbox"/> 9605A162
	Giunto lineare con contatti / Electrical straight connector	<input type="checkbox"/> 9605A141	<input checked="" type="checkbox"/> 9605A142		Tappo di chiusura del binario / Track dead end cap	<input type="checkbox"/> 9605A131	<input checked="" type="checkbox"/> 9605A132
	Giunto lineare isolante senza contatti / Mechanical straight insulating connector	<input type="checkbox"/> 9605A301	<input checked="" type="checkbox"/> 9605A302		Pinza per taglio conduttori elettrici / Cutting tool for electric conductors	<input type="checkbox"/> 9605AA997	



Omnia GB

Omnia GB implementa le funzionalità del profilo Omnia GA, consentendo l'integrazione di moduli o prodotti per l'illuminazione diretta. Grazie alla flessibilità di installazione, Omnia GB può essere adattato su misura ad ogni singolo progetto. Il sistema GB offre varie alternative per valorizzare i progetti architettonici attraverso l'illuminazione diretta, tra cui sorgenti luminose diffondenti, darklight e sospensioni.

Omnia GB enhances the functionality of the Omnia GA profile by allowing the integration of modules or products for direct lighting. Its installation flexibility enables tailoring to each project. The GB system offers various alternatives for enhancing architectural designs through direct lighting, including diffusing light sources, dark-lights, and suspensions.

Predisposizione per il fissaggio del binario trifase e dei proiettori
Predisposition for three-phases track and spotlight installation

Predisposizione per l'installazione di cover diffondente o microprismata
Predisposition for diffuse or microprismatic cover installation

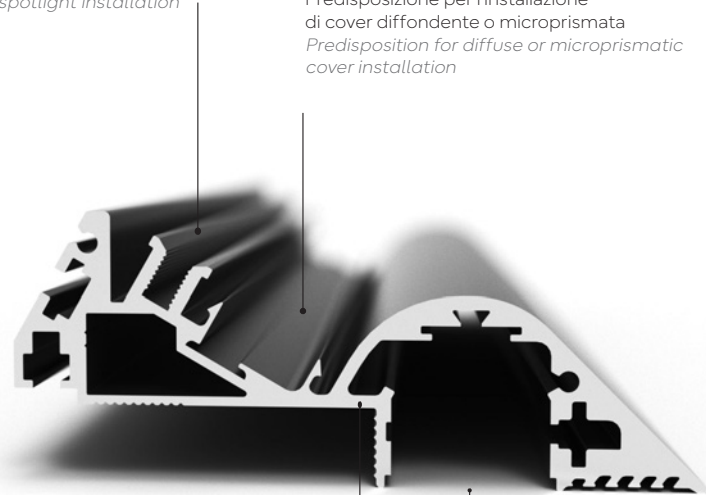

Passaggio cavi per alimentazione luce diretta
Cable passage for direct lighting supply

Installazione Estro JA per illuminazione diretta
Installation of Estro JA for direct lighting



GB module

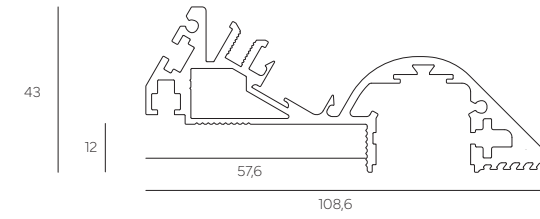

Codice base Base code	Lunghezza mm Length mm	Colore Finishes	Peso Kg Weight Kg
GB	100	B Bianco / White	2.0
	200	W Nero / Black	4.0
	300		6.0

Profilo in alluminio dedicato alla creazione di sistemi di gole luminose. Predisposto per luce indiretta, diretta e spot.
Aluminium profile for cove lighting systems. This system is available with indirect and direct light and spot lights.

Accessori di installazione / Installation Accessories

	Giunto lineare / Linear joint	GAJNTA		Staffa per fissaggio su struttura / Structure fixing bracket	GASTRW	GASTRB	
	Giunto Angolare / Angular Joint	GAJ90A		Staffa per binario main voltage / Main voltage track bracket	GATRKW	GATRKB	
	Staffa per Sospensione / Suspension bracket	GAPENW	GAPENB		Giunto angolare interno / System inner angular joint	GBI90W	GBI90B
	Chiusura finale per sistemi a doppio lato / Two sided system end-cap	GBENDW	GBENDB		Giunto angolare esterno / System outer angular joint	GBE90W	GBE90B

Binario Trifase / Main Voltage Track



Codice base Base code	Lunghezza mm Length mm	Colore Finishes	Peso Kg Weight Kg	
9605	A01	1000	1 Bianco / White	1.05 kg
	A02	2000	2 Nero / Blac	2.04 kg
	A03	3000	0 Grigio / Gray	3.06 kg

	Testata polarità destra / Right polarity end-feed	9605A121	9605A122		Testata centrale / Middle feed connector	9605A261	9605A262
	Testata polarità sinistra / Left polarity end-feed	9605A151	9605A152		Giunto flessibile / Flexible connector	9605A161	9605A162
	Giunto lineare con contatti / Electrical straight connector	9605A141	9605A142		Tappo di chiusura del binario / Track dead end cap	9605A131	9605A132
	Giunto lineare isolante senza contatti / Mechanical straight insulating connector	9605A301	9605A302		Pinza per taglio conduttori elettrici / Cutting tool for electric conductors	9605AA997	



Omnia spot

Omnia Spot è un proiettore a scomparsa compatibile con i sistemi Omnia che includono un binario trifase. Dotato di un braccio snodabile, consente un preciso puntamento all'interno dei sistemi a gola. Grazie all'integrazione nel sistema a binario, può essere posizionato con facilità lungo l'intera composizione, eliminando la necessità di alimentatori remoti e semplificando così la fase di posa dei punti luce.

Omnia Spot is a cove lighting fixture compatible with all Omnia systems that include Mains Voltage track. Equipped with an adjustable bracket, it allows precise focusing inside cove lighting systems. Thanks to its integration in the track system, it can be easily positioned along the entire composition, eliminating remote drivers and simplifying the installation.

Omnia spot



Up to
18 W

Caratteristiche illuminotecniche / Lighting specs

Watt	Watt LED	mA	IRC/CRI	CCTs	Nom lm	Del lm
12.5	11.8	350	>90	2700K	1539	1179
				3000K	1618	1239
				4000K	1700	1302
18	17.4	500	>90	2700K	2124	1627
				3000K	2235	1712
				4000K	2347	1798

Codice base Base code	Temperatura Temperature	Potenza Power	Fascio Beam	Finitura Finishing	Alimentazione Driver	Montaggio Mounting
2025	Z 2700K	B 12.5W	B 12°	1 Bianco White	E On-Off	E01 Track
	7 3000K	C 18W	F 24°	2 Nero Black	L DALI	
	8 4000K		M 38°		C Casambi	
			T 60°			

* A richiesta è possibile configurare il prodotto con LED speciali e temperature colore dedicate.
Special LEDs and specific colour temperatures can be configured on request.

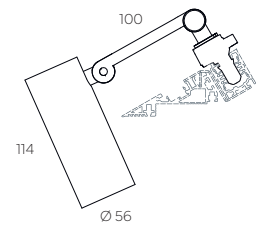
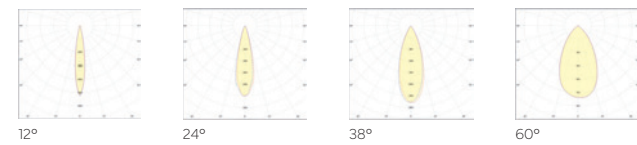

0,5 Kg

Bianco
White
Nero
Black

Finiture custom
Custom finishes

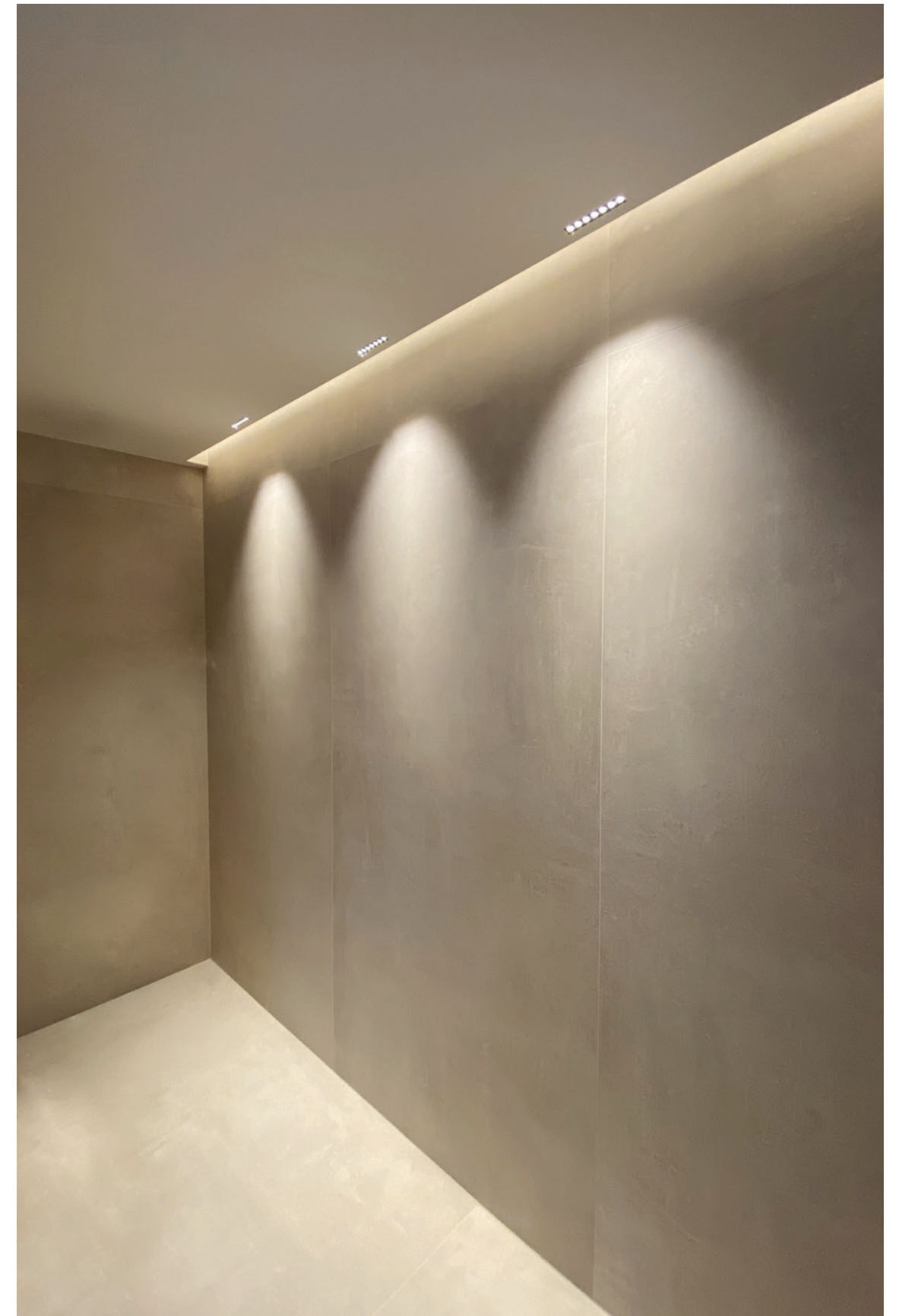

Accessori / Accessories

Frangiluce
Honeycomb

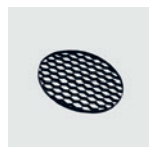

Magic K/XS KSGRI

Lenti
Lenses

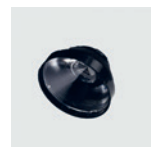

Magic K/XS

12° 202512
24° 202524
38° 202538
60° 202560



Omnia lights

Il sistema Omnia supporta diverse tipologie di prodotti come strip led e diffusori opali per la luce indiretta. Inoltre, il modulo GB consente l'integrazione dei moduli Excel e Ice Pendant per una fonte di illuminazione diretta integrata nel cartongesso.

The Omnia system supports different types of products such as LED strips and opal diffusers for indirect lights. In addition, the GB system allows the integration of Excel and Ice Pendant modules for a direct light source integrated in plasterboard.

Omnia direct lighting

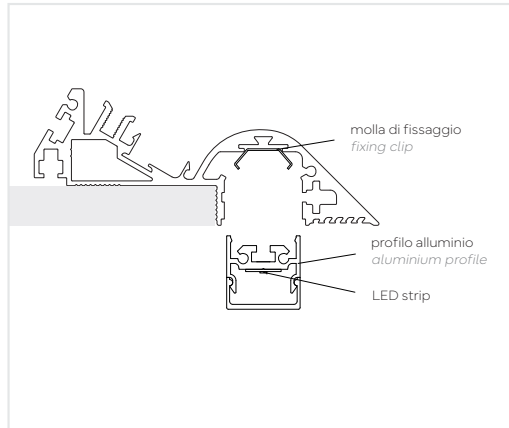

Profilo Alluminio e accessori
Aluminium profile and accessories

1 m	JAO100A
2 m	JAO200A
3 m	JAO300A
Tappo / End-cap	JAT
Molla / Clip	JAM

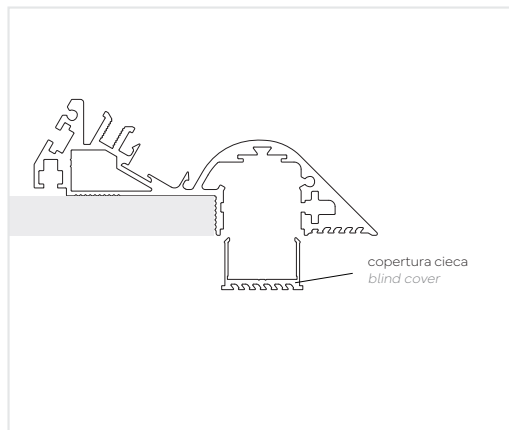

Copertura cieca da rasare
Blind cover to be levelled

1 m	GBI100
2 m	GBI200
3 m	GBI300

Omnia Indirect lighting

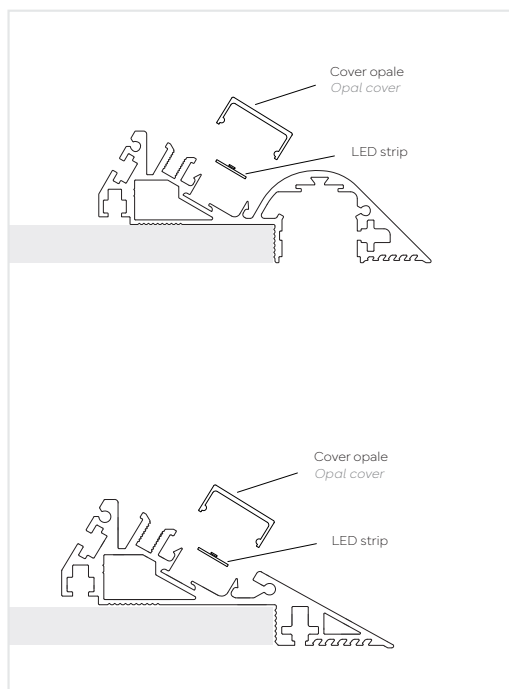

LED strip 24V
14.4 W/m - 240 LEDs/m - 1350 lm/m

2700K	SV2700
3000K	SV3000
4000K	SV4000

19.2 W/m - 240 LEDs/m - 2000 lm/m

2700K	ST2700
3000K	ST3000
4000K	ST4000

Copertura opale
Opal cover

1 m	OPAL100
2 m	OPAL200
3 m	OPAL300

Driver 24V

60 W on/off	SL60-24VF	60 W DALI	SDL60-24VF
100 W on/off	SL100-24VF	100 W DALI	SDL100-24VF
150 W on/off	SNP150-24VF	150 W DALI	SDL150-24VF

Omnia Ice

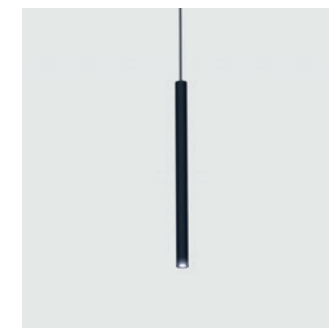

2 W

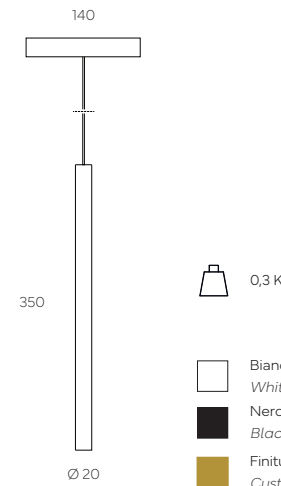

Caratteristiche illuminotecniche / Lighting specs

Watt	Watt LED	mA	IRC/CRI	CCTs	Nom lm	Del lm
2	1.7	350	>90	2700K	195	162
				3000K	195	162
				3500K	195	162
				4000K	195	162

Codice base Base code	Temperatura Temperature	Potenza Power	Fascio Beam	Finitura Finishing	Alimentazione Driver
1150	Z 2700K	B 2W	G 25°	1 Bianco White	E On-Off L DALI
	7 3000K		N 40°		
	0 3500K		T 60°		
	8 4000K		1 80°		

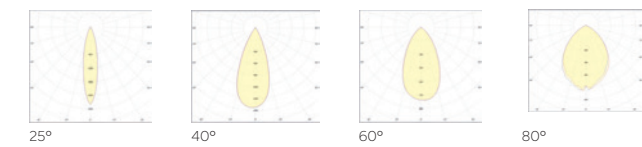

Omnia Excel UGR<19

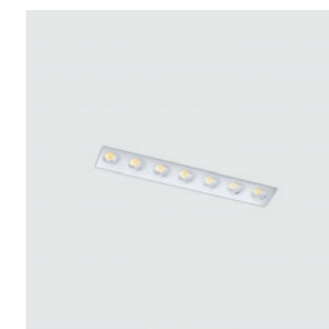

8.4W

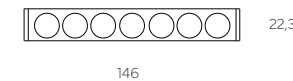

0,2 Kg

Bianco
White
Nero
Black

Caratteristiche illuminotecniche / Lighting specs

Watt	Watt LED	mA	IRC/CRI	CCTs	Nom lm	Del lm
/	8.4W	/	>90	2700K	1057	823
				3000K	1057	823
				4000K	1057	823

Codice base Base code	Potenza Power	Temperatura Temperature	Fascio Beam	Finitura Finishing	Alimentazione Driver
JAE	L 8.4W	A 2700K	C 15°	WW Bianco White	- Driver Remoto Remote Driver
		B 3000K	K 30°		
		C 4000K	R 50°	BB Nero Black	

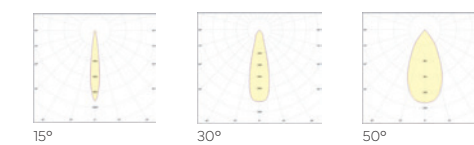

Downlights

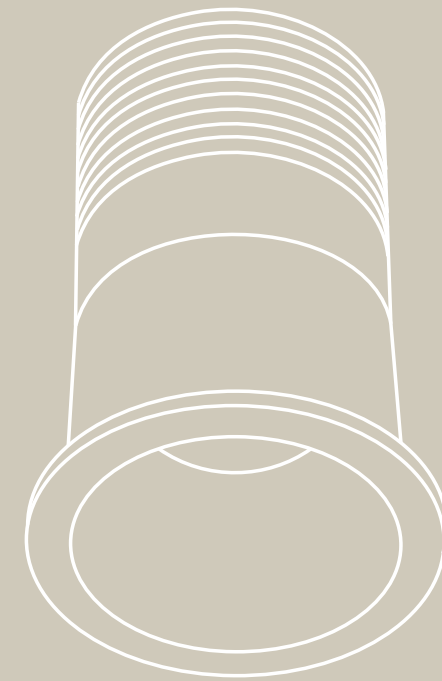

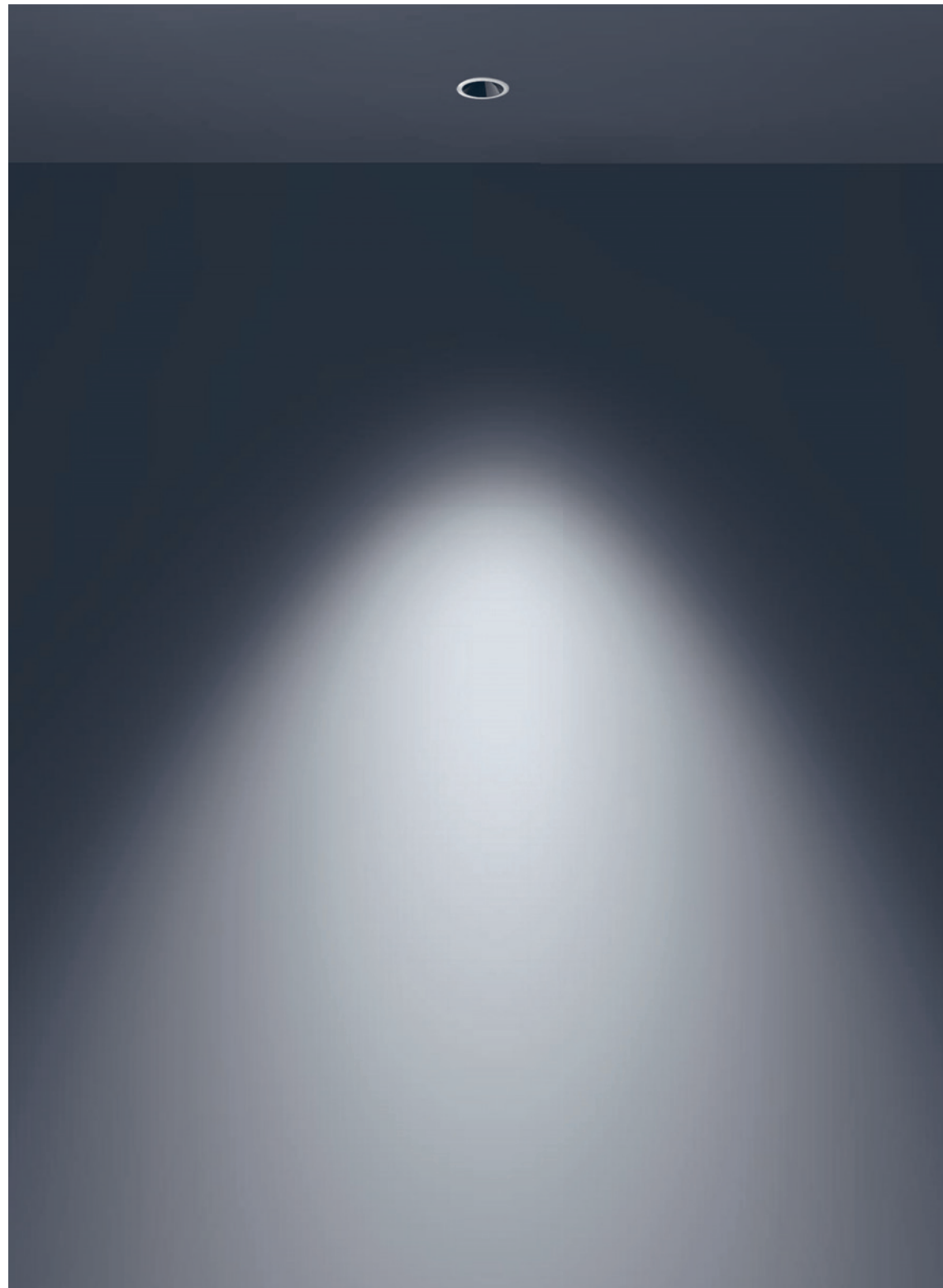

Dot

La gamma Dot è pensata principalmente per l'integrazione nell'arredamento e si distingue per le dimensioni compatte e la flessibilità d'uso. Disponibili in quattro diverse dimensioni, questi incassi sono ideali per applicazioni come librerie, guardaroba e nicchie. Gli incassi Dot offrono un'eccellente soluzione per la luce d'accento e la valorizzazione di oggetti in esposizione.

The recessed Dot family is primarily designed for integration into furniture. It is characterized by compact dimensions and application flexibility. Available in four different sizes, these luminaries are ideal for accent lighting and for various applications such as bookcases, wardrobes, and niches.

Dot 30

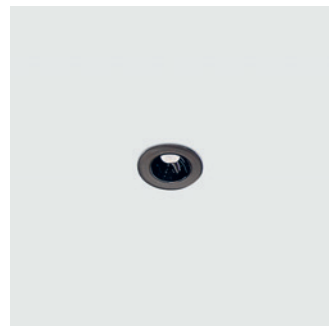

2 W

Caratteristiche illuminotecniche / Lighting specs

Watt	Watt LED	mA	IRC/CRI	CCTs	Nom lm	Del lm
2	1.5	500	>90	2700K	130	106
				3000K	137	109
				4000K	144	117

Codice base Base code	Temperatura Temperature	Potenza Power	Fascio Beam	Finitura Finishing	Alimentazione Driver
3006	Z 2700K	C 2W	C 15°	1 Bianco White	- Not included
	7 3000K		F 24°	E On-Off	
	8 4000K		P 45°	2 Nero Black	D Push (remote)
			L DALI (remote)		

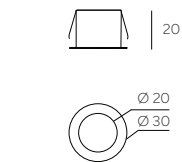
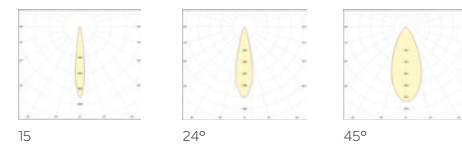

0,1 Kg
25 mm

Bianco
White
Nero
Black

Dot 40

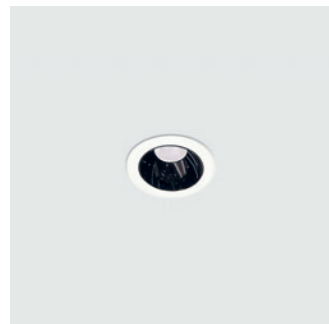

3 W

Caratteristiche illuminotecniche / Lighting specs

Watt	Watt LED	mA	IRC/CRI	CCTs	Nom lm	Del lm
3	2.3	700	>90	2700K	204	151
				3000K	218	161
				4000K	234	195

Codice base Base code	Temperatura Temperature	Potenza Power	Fascio Beam	Finitura Finishing	Alimentazione Driver
3007	Z 2700K	D 3W	C 15°	1 Bianco White	- Not included
	7 3000K		F 24°	E On-Off	
	8 4000K		P 45°	2 Nero Black	D Push (remote)
			L DALI (remote)		

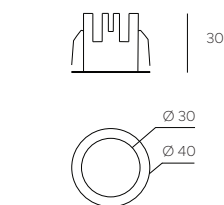
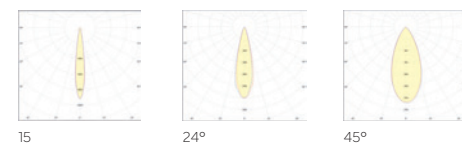

0,1 Kg
35 mm

Bianco
White
Nero
Black

Dot 55

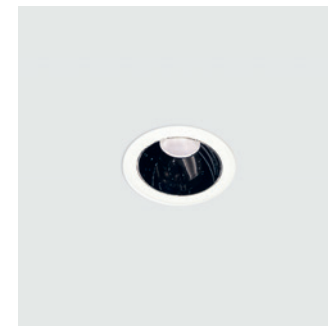

4 W

Caratteristiche illuminotecniche / Lighting specs

Watt	Watt LED	mA	IRC/CRI	CCTs	Nom lm	Del lm
4	3.5	1150	>90	2700K	321	228
				3000K	355	283
				4000K	371	303

Codice base Base code	Temperatura Temperature	Potenza Power	Fascio Beam	Finitura Finishing	Alimentazione Driver
3008	Z 2700K	I 4W	C 15°	1 Bianco White	- Not included
	7 3000K		F 24°	E On-Off	
	8 4000K		P 45°	2 Nero Black	D Push (remote)
			L DALI (remote)		

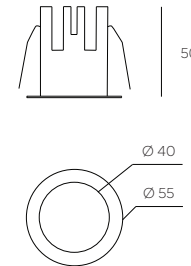
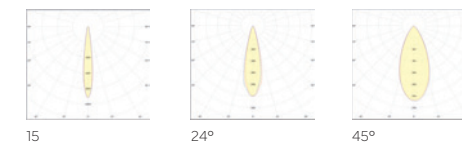

0,2 Kg
50 mm

Bianco
White
Nero
Black

Accessori / Accessories

Alimentatore On/Off + Push
Driver On/Off + Push



Per connessione in serie 2 - max 11 pcs
For series connection 2 - 11 units max

Alimentatore DALI
Driver DALI



Per connessione in serie 2 - max 11 pcs
For series connection 2 - 11 units max

Alimentatore Casmbi
Driver Casambi



Per connessione in serie 2 - max 11 pcs
For series connection 2 - 11 units max

Riflettore Nero
Black Reflector



Dot 30 300611
Dot 40 300711
Dot 55 300811

Riflettore Bianco
White Reflector



Dot 30 300610
Dot 40 300710
Dot 55 300810

Dot 65

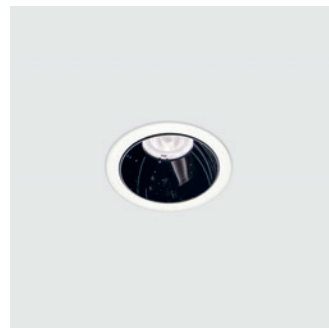

8 W

Caratteristiche illuminotecniche / Lighting specs

Watt	Watt LED	mA	IRC/CRI	CCTs	Nom lm	Del lm
8	7.2	200	>90	2700K 3000K 4000K	654 732 792	569 581 610

Codice base Base code	Temperatura Temperature	Potenza Power	Fascio Beam	Finitura Finishing	Alimentazione Driver
3009	Z 2700K	2 8W	C 15°	1 Bianco White	- Not included
	7 3000K		F 24°	2 Nero Black	E On-Off
	8 4000K		P 45°		D Push L DALI C Casambi

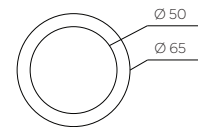
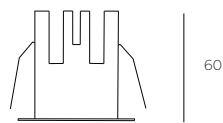

0,2 Kg

60 mm

Bianco
White

Nero
Black

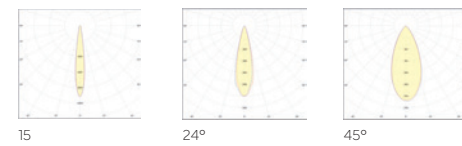

Accessori / Accessories

Kit luce di emergenza
Emergency light



kit 1 h 123010
kit 3 h 123023/3

Riflettore Nero
Black Reflector



300911

Riflettore Bianco
White Reflector



300910





Isi

Pensati per l'ambito residenziale e ricettivo, gli incassi ISI sono disponibili in tre diversi diametri e si adattano perfettamente a spazi con un'altezza massima di 3,5 metri. Grazie alla fonte luminosa particolarmente recessata, offrono un'elevato comfort visivo. La ghiera minimale consente un'installazione discreta, quasi invisibile all'interno della superficie di installazione.

Designed for residential and hospitality, ISI downlights are available in three different diameters and fit perfectly in spaces up to 3.5 meters high. The downlights offer high visual comfort due to their particularly recessed light source. The minimalist ring allows discreet installations, almost invisible on the surfaces.



ISI dispone di una selezione di ghiera di diverso colore: nero, bianco, oro e argento. Tali opzioni consentono di personalizzare il prodotto per integrarsi perfettamente con le finiture dei vari progetti architettonici.

ISI offers a wide range of rings in different colors: black, white, gold and silver. These options enable to customize the product to match the finishes of different architectural projects.

Isi 40 UGR<19

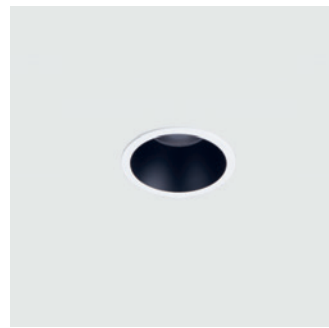

3 W

Caratteristiche illuminotecniche / Lighting specs

Watt	Watt LED	mA	IRC/CRI	CCTs	Nom lm	Del lm
3	2.8	700	>90	2700K	249	188
				3000K	262	198
				4000K	282	213

Codice base Base code	Temperatura Temperature	Potenza Power	Fascio Beam	Finitura Finishing	Alimentazione Driver
3000	Z 2700K	2 3 W	E 17°	1 Tutto Bianco All White	- Not included
	7 3000K		H 26°	E On-Off	
	8 4000K		2 Tutto Nero All Black	D Push (remote) L DALI (remote) C Casambi (remote)	

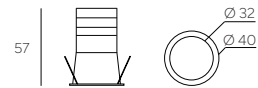

0,2 Kg
35 mm

Bianco
White
Nero
Black

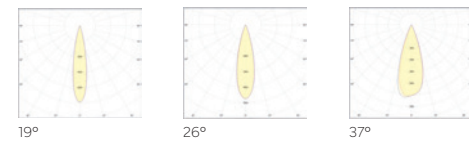

Isi 75 UGR<19



12 W

Caratteristiche illuminotecniche / Lighting specs

Watt	Watt LED	mA	IRC/CRI	CCTs	Nom lm	Del lm
12	10.8	300	>90	2700K	1176	800
				3000K	1260	857
				4000K	1320	898

Codice base Base code	Temperatura Temperature	Potenza Power	Fascio Beam	Finitura Finishing	Alimentazione Driver
3002	Z 2700K	3 12W	D 18°	1 Tutto Bianco All White	- Not included
	7 3000K		3 22°	E On-Off	
	8 4000K		J 32°	2 Tutto Nero All Black D Push L DALI C Casambi	

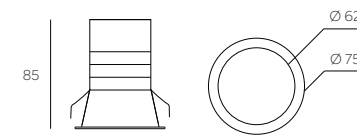

0,3 Kg
65 mm

Bianco
White
Nero
Black

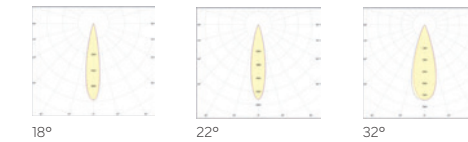

Isi 55 UGR<19

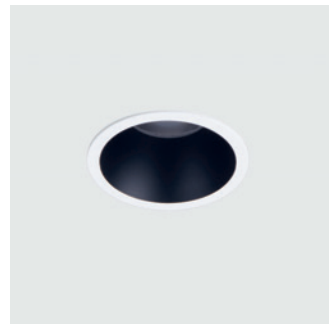

8 W

Caratteristiche illuminotecniche / Lighting specs

Watt	Watt LED	mA	IRC/CRI	CCTs	Nom lm	Del lm
8	72	200	>90	2700K	784	592
				3000K	840	634
				4000K	880	664

Codice base Base code	Temperatura Temperature	Potenza Power	Fascio Beam	Finitura Finishing	Alimentazione Driver
3001	Z 2700K	2 8W	E 19°	1 Tutto Bianco All White	- Not included
	7 3000K		H 26°	E On-Off	
	8 4000K		L 37°	D Push L DALI C Casambi (remote)	

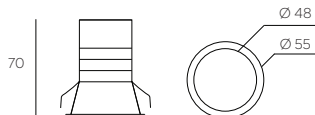

0,2 Kg
50 mm

Bianco
White
Nero
Black

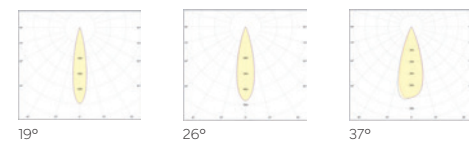

Accessori / Accessories

<p>Kit luce di emergenza Emergency light</p> <p>kit 1 h 123010 kit 3 h 123023/3</p>	<p>Alimentatore On/Off + Push Driver On/Off + Push</p> <p>Per connessione in serie 2 - max 11 pcs For series connection 2 - 11 units max</p> <p>125400</p>	<p>Alimentatore DALI Driver DALI</p> <p>Per connessione in serie 2 - max 11 pcs For series connection 2 - 11 units max</p> <p>151403</p>	<p>Alimentatore Casambi Driver Casambi</p> <p>Per connessione in serie 2 - max 11 pcs For series connection 2 - 11 units max</p> <p>127630</p>	<p>Nero/Anello Frontale Bianco Black/White Front Ring</p> <p>Isi 40 300011 Isi 55 300111 Isi 75 300211</p>
<p>Oro/Anello Frontale Bianco Gold/White Front Ring</p> <p>Isi 40 300014 Isi 55 300114 Isi 75 300214</p>	<p>Argento/Anello Frontale Bianco Silver/White Front Ring</p> <p>Isi 40 300013 Isi 55 300113 Isi 75 300213</p>	<p>Bianco/Anello Frontale Nero White/Black Front Ring</p> <p>Isi 40 300020 Isi 55 300120 Isi 75 300220</p>	<p>Oro/Anello Frontale Nero Gold/Black Front Ring</p> <p>Isi 40 300024 Isi 55 300124 Isi 75 300224</p>	<p>Argento/Anello Frontale Silver/Black Front Ring</p> <p>Isi 40 300023 Isi 55 300123 Isi 75 300223</p>



Gear

Gear, disponibile sia in versione trim che trimless, è un prodotto completo che garantisce flessibilità di installazione per molteplici tipi di applicazioni. La sorgente luminosa recessata assicura un elevato comfort visivo. La regolazione dell'orientamento luminoso, tramite apposita vite, risulta estremamente semplice. Il grado di protezione IP65 rende il prodotto adatto anche ad applicazioni in esterno.

Available in both trim and trimless versions, Gear offers installation flexibility for many types of applications. The recessed light source ensures optimal visual comfort. A special screw makes extremely easy to adjust the light direction. The product's IP65 rating makes it also suitable for outdoor applications.



Gear permette una manutenzione semplice e veloce: la sorgente luminosa, completa di dissipatore, può essere sostituita facilmente senza rimuovere la contro-cassa di installazione. Inoltre, il prodotto è dotato di un'ampia selezione di riflettori e filtri.

Gear allows quick and easy maintenance: the light source, complete with heat-sink, can be easily replaced without removing the recessed housing. In addition, the product comes with a wide selection of reflectors and filters.

Gear Round Trim UGR<10

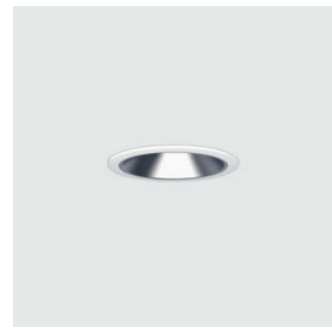

Up to 15 W

Caratteristiche illuminotecniche / Lighting specs

Watt	Watt LED	mA	IRC/CRI	CCTs	Nom lm	Del lm
10	9	250	>90	2700K	1008	685
				3000K	1064	724
				4000K	1128	767
15	12.6	350	>90	2700K	1354	921
				3000K	1429	972
				4000K	1515	1030

Codice base Base code	Temperatura Temperature	Potenza Power	Fascio Beam	Finitura Finishing	Alimentazione Driver
3003	Z 2700K	A 10W	3 18°	1 Bianco White	- Not included E On-Off D Push L DALI C Casambi
	7 3000K		B 15W		
	8 4000K	2 Nero Black	M 38°		
			R 50°		

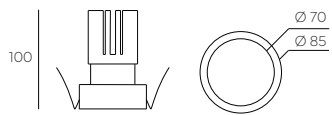

0,3 Kg
75 mm

Bianco
White
Nero
Black

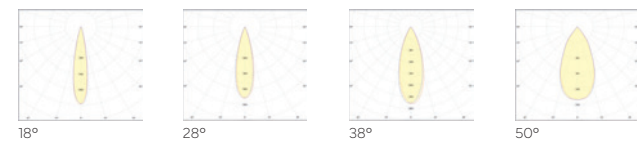

Gear Square Trim UGR<10



Up to 15 W

Caratteristiche illuminotecniche / Lighting specs

Watt	Watt LED	mA	IRC/CRI	CCTs	Nom lm	Del lm
10	9	250	>90	2700K	1008	685
				3000K	1064	724
				4000K	1128	767
15	12.6	350	>90	2700K	1354	921
				3000K	1429	972
				4000K	1515	1030

Codice base Base code	Temperatura Temperature	Potenza Power	Fascio Beam	Finitura Finishing	Alimentazione Driver
3005	Z 2700K	A 10W	3 18°	1 Bianco White	- Not included E On-Off D Push L DALI C Casambi
	7 3000K		B 15W		
	8 4000K	2 Nero Black	M 38°		
			R 50°		

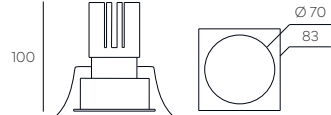

0,4 Kg
75 mm x 75 mm

Bianco
White
Nero
Black

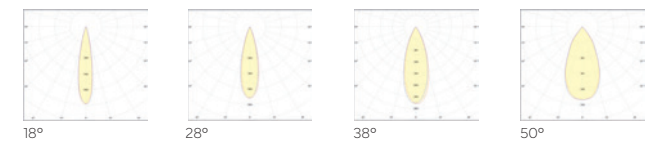

Gear Round Trimless UGR<10

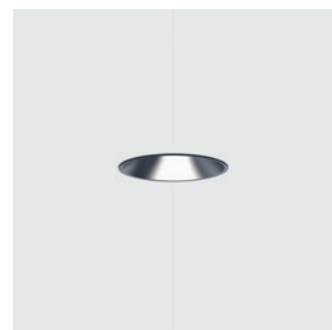

Up to 15 W

Caratteristiche illuminotecniche / Lighting specs

Watt	Watt LED	mA	IRC/CRI	CCTs	Nom lm	Del lm
10	9	250	>90	2700K	1008	685
				3000K	1064	724
				4000K	1128	767
15	12.6	350	>90	2700K	1354	921
				3000K	1429	972
				4000K	1515	1030

Codice base Base code	Temperatura Temperature	Potenza Power	Fascio Beam	Finitura Finishing	Alimentazione Driver
3004	Z 2700K	A 10W	3 18°	1 Bianco White	- Not included E On-Off D Push L DALI C Casambi
	7 3000K		B 15W		
	8 4000K	2 Nero Black	M 38°		
			R 50°		

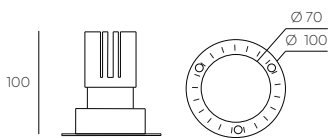

0,4 Kg
75 mm

Bianco
White
Nero
Black

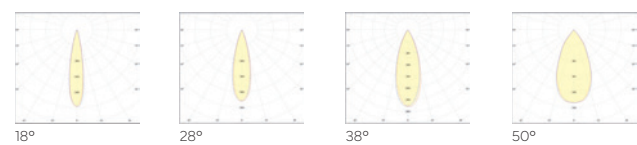

Accessori / Accessories

Kit luce di emergenza
Emergency light



kit 1 h 123010
kit 3 h 123023/3

Riflettore Nero
Black Reflector



Gear R Trim 300311
Gear R Trimless 300411
Gear S Trim 300511

Riflettore Bianco
White Reflector



Gear R Trim 300310
Gear R Trimless 300410
Gear S Trim 300510

Riflettore Cromo
Chromed Reflector



Gear R Trim 300312
Gear R Trimless 300412
Gear S Trim 300512

Riflettore Argento Satinato
Matt Silver Reflector



Gear R Trim 300313
Gear R Trimless 300413
Gear S Trim 300513

Filtro Pinhole
Pinhole Filter



Gear R Trim 300320
Gear R Trimless 300420
Gear S Trim 300520

Filtro Ovalhole
Ovalhole Filter

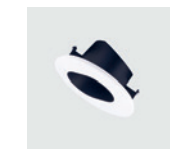

Gear R Trim 300321
Gear R Trimless 300421
Gear S Trim 300521

Frangiluce
Honeycomb

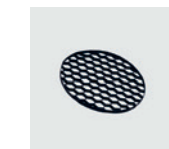

Gear R Trim 3003GRI
Gear R Trimless 3004GRI
Gear S Trim 3005GRI



Smart E

Smart E offre la massima flessibilità. La ghiera rimovibile permette installazioni sia in versione trim che trimless. Il prodotto può essere inoltre utilizzato sia come incasso fisso, sia come incasso estraibile. Se estratto completamente permette l'orientabilità del corpo a 355°.

Smart E offers high flexibility. The removable ring allows both trim and trimless installations. The product can also be used both as a fixed recessed and a pull-out recessed light. When fully extracted, the body can be adjusted up to 355°.

Smart E/XXS

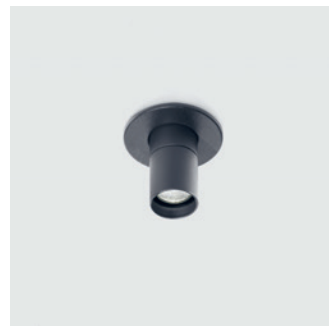

4.4 W

Caratteristiche illuminotecniche / Lighting specs

Watt	Watt LED	mA	IRC/CRI	CCTs	Nom lm	Del lm
4.4	3.4	100	>90	2700K	379	307
				3000K	420	340
				4000K	429	347

Codice base Base code	Temperatura Temperature	Potenza Power	Fascio Beam	Finitura Finishing	Alimentazione Driver
2120	Z 2700K	0 4.4W	3 28°	1 Bianco White	- Not included
	7 3000K		8 33°	E On-Off	
	8 4000K		M	2 Nero Black	D Push (remote)
			R	L DALI (remote)	

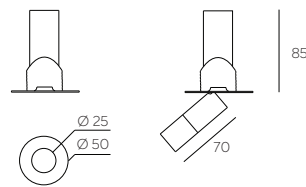

0,1 Kg
40 mm

Bianco
White
Nero
Black

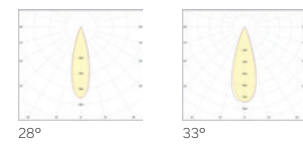

Smart E XXS può essere installato sia in versione trim che in versione trimless, rimuovendo l'apposito anello fornito con il prodotto.

Smart E XXS can be installed in both trim and trimless versions by removing the ring supplied with the product.



Installazione Trimless / Trimless installation



Installazione Trim / Trim installation

Accessori / Accessories

Kit luce di emergenza
Emergency light



kit 1 h 123010
kit 3 h 123023/3

Smart E/XS



8.4 W

Caratteristiche illuminotecniche / Lighting specs

Watt	Watt LED	mA	IRC/CRI	CCTs	Nom lm	Del lm
8.4	6.9	350	>90	2700K	920	653
				3000K	1002	711
				4000K	1080	767

Codice base Base code	Temperatura Temperature	Potenza Power	Fascio Beam	Finitura Finishing	Alimentazione Driver
2130	Z 2700K	2 8.4W	E 25°	1 Bianco White	- Not included
	7 3000K		N 40°	2 Nero Black	E On-Off
	8 4000K				D Push (remote)
					L DALI (remote)
					C Casambi (remote)

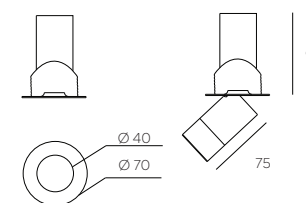

0,1 Kg
55 mm

Bianco
White
Nero
Black

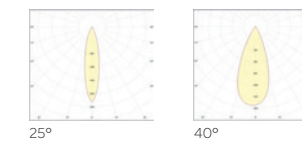

Smart E XS può essere installato sia in versione trim che in versione trimless, rimuovendo l'apposito anello fornito con il prodotto.

Smart E XS can be installed in both trim and trimless versions by removing the ring supplied with the product.



Installazione Trimless / Trimless installation



Installazione Trim / Trim installation

Accessori / Accessories

Kit luce di emergenza
Emergency light



kit 1 h 123010
kit 3 h 123023/3



Sun & Point IP

Sun, con un profondità d'incasso di soli 33 mm, è l'ideale per installazioni dove lo spazio tra contro-soffitto e soletta è molto limitato. Point IP è invece indicato per applicazioni in ambienti umidi o a contatto con spruzzi d'acqua.

Sun, with a recessed depth of only 33 mm, is ideal for installations where space between ceiling and plasterboard is very limited. Point IP is suitable for applications in humid or exposed to sprinkling water environments.

Sun

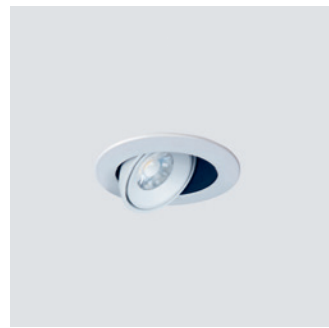

8.3W

Caratteristiche illuminotecniche / Lighting specs

Watt	Watt LED	mA	IRC/CRI	CCTs	Nom lm	Del lm
8.3	6.8	200	>90	3000K 4000K	1036 1089	777 817

Codice base Base code	Temperatura Temperature	Potenza Power	Fascio Beam	Finitura Finishing	Alimentazione Driver
0900	2 3000K	2 8.3W	D 17°	1 Bianco White	- Not included
	3 4000K		N 40°	2 Nero Black BN Nichel Nikel	E On-Off D Push L DALI

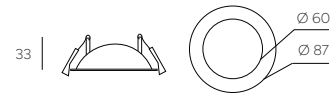

0,2 Kg

70 mm

Bianco
White

Nero
Black

Nichel Spazzolato
Brushed Nickel

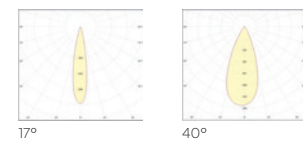

Point IP65



14.9W

Caratteristiche illuminotecniche / Lighting specs

Watt	Watt LED	mA	IRC/CRI	CCTs	Nom lm	Del lm
14.9	12.7	350	>90	3000K 4000K	1580 1615	1264 1292

Codice base Base code	Temperatura Temperature	Potenza Power	Fascio Beam	Finitura Finishing	Alimentazione Driver	
0874	7 3000K	B 14.9W	E 20°	1 Bianco White	- Not included	
	8 4000K		N 40°			E On-Off
			T 60°			D Push L DALI

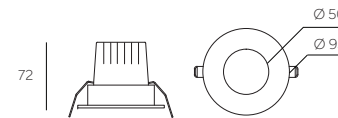

0,2 Kg

85 mm

Bianco
White

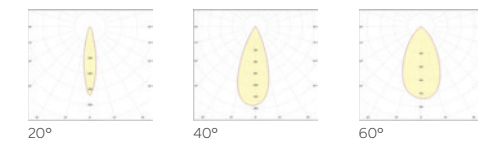

Sun/P

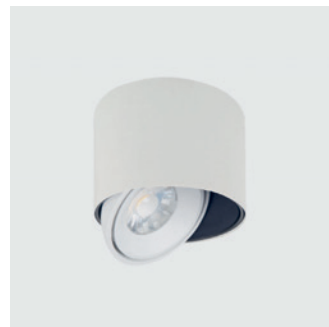

8.3W

Caratteristiche illuminotecniche / Lighting specs

Watt	Watt LED	mA	IRC/CRI	CCTs	Nom lm	Del lm
8.3	6.8	200	>90	3000K 4000K	1036 1089	777 817

Codice base Base code	Temperatura Temperature	Potenza Power	Fascio Beam	Finitura Finishing	Alimentazione Driver
4830	2 3000K	2 8.3W	D 17°	1 Bianco White	E On-Off
	3 4000K		N 40°	2 Nero Black BN Nichel Nikel	D Push L DALI



0,3 Kg

70 mm

Bianco
White

Nero
Black

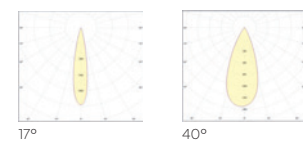

Excel

Excel, disponibile nelle varianti trim, trimless e trimless wallwasher, offre un'illuminazione lineare puntiforme ideale per le aree di passaggio. Questa famiglia di prodotti è estremamente versatile e di facile manutenzione: è composta da una contro-cassa e un modulo luminoso facilmente rimovibile. Grazie all'alimentazione a 24V, è possibile raggruppare diversi punti luce riducendo al minimo la presenza di alimentatori.

Available in trim, trimless and trimless wall-washer, Excel is a linear spot lighting ideal for hallways. This product is extremely versatile and easy to maintain. The light module is easy to be removed. Due to the 24V power supply, several lighting points can be grouped together, minimizing the numbers for drivers.

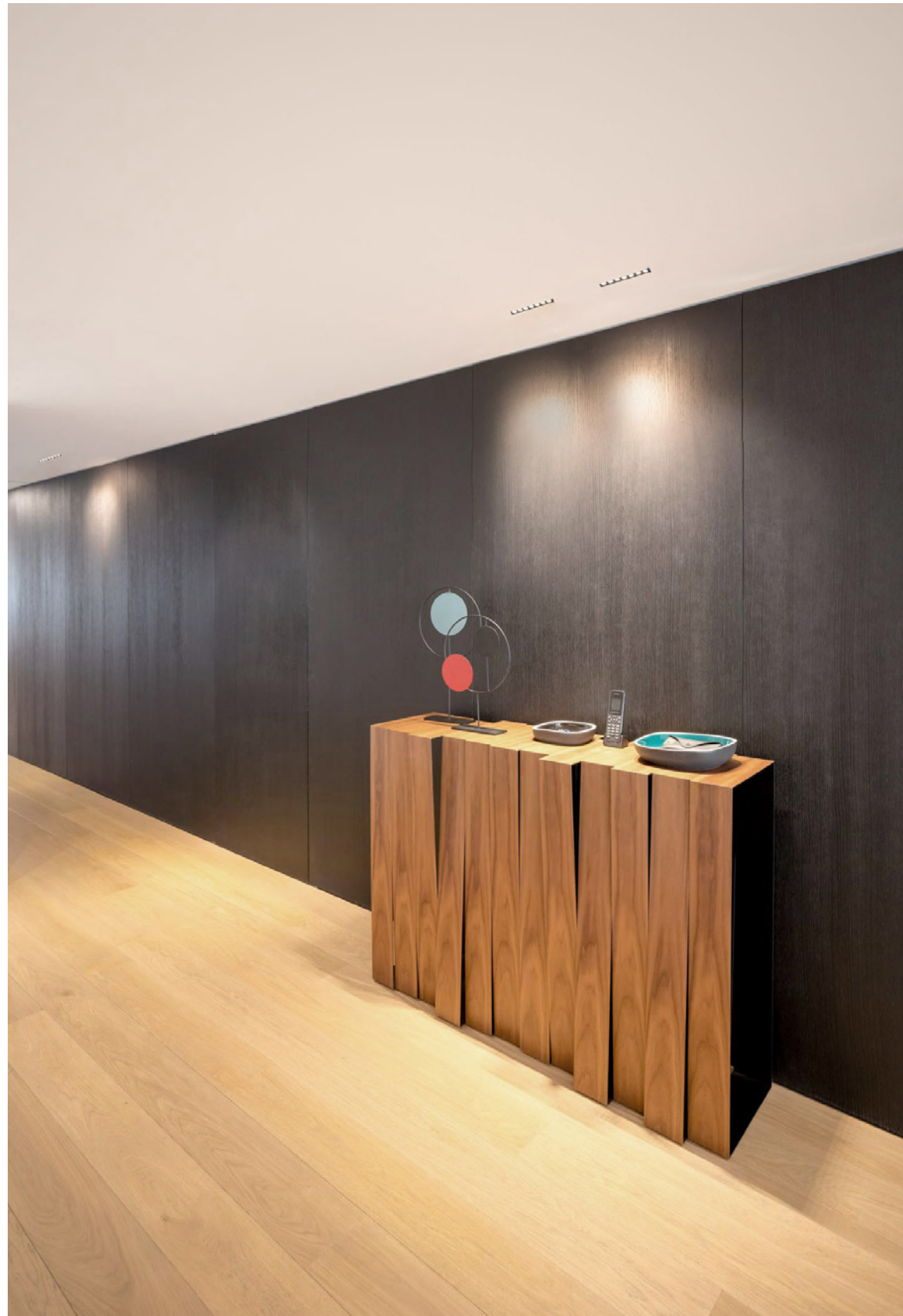

Excel è la prima produzione Ilmas sviluppata e realizzata all'interno del gruppo HB4. Grazie all'esperienza dei nostri uffici di progettazione, sia ottica che elettronica, Ilmas ha potuto realizzare prodotti dall'alta precisione ottica e dalle elevate prestazioni illuminotecniche.

Excel is the first Ilmas product designed and developed in-house by the HB4 Group. Thanks to the experience of our design offices, both optical and electronic, Ilmas has been able to create products with high optical precision and considerable lighting output.

Excel Trim UGR<19



8.4 W

Caratteristiche illuminotecniche / Lighting specs

Watt	Watt LED	mA	IRC/CRI	CCTs	Nom lm	Del lm
/	8.4	/	>90	2700K	1057	823
				3000K	1057	823
				4000K	1057	823

Codice base Base code	Potenza Power	Temperatura Temperature	Fascio Beam	Finitura Finishing	Alimentazione Driver
JCE	L 8.4W	A 2700K	C 15°	WW Bianco White	- Driver Remoto Remote Driver
		B 3000K	K 30°	BB Nero Black	
		C 4000K	R 50°		

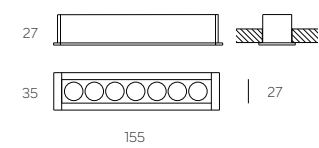

- 0,2 Kg
- 148 mm x 29 mm
- Bianco
White
- Nero
Black
- Finiture custom
Custom finishes

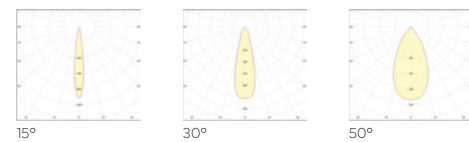

Excel Trimless Wall Washer UGR<19



8.4 W

Caratteristiche illuminotecniche / Lighting specs

Watt	Watt LED	mA	IRC/CRI	CCTs	Nom lm	Del lm
/	8.4	/	>90	2700K	1057	823
				3000K	1057	823
				4000K	1057	823

Codice base Base code	Potenza Power	Temperatura Temperature	Fascio Beam	Finitura Finishing	Alimentazione Driver
JHE	L 8.4W	A 2700K	C 15°	WW Bianco White	- Driver Remoto Remote Driver
		B 3000K	K 30°	BB Nero Black	
		C 4000K	R 50°		

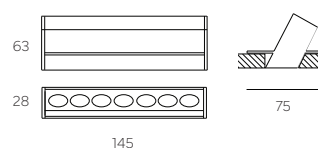

- 0,2 Kg
- 148 mm x 28 mm
- Bianco
White
- Nero
Black
- Finiture custom
Custom finishes

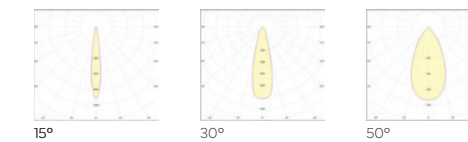

NB: Installabile solo con cartongesso da posare / NB: Only for plasterboard to be installed

Excel Trimless UGR<19

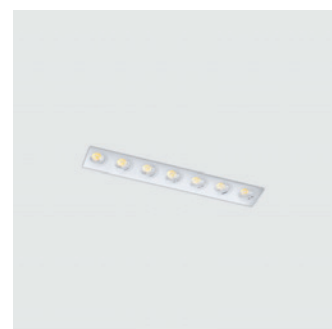

8.4 W

Caratteristiche illuminotecniche / Lighting specs

Watt	Watt LED	mA	IRC/CRI	CCTs	Nom lm	Del lm
/	8.4W	/	>90	2700K	1057	823
				3000K	1057	823
				4000K	1057	823

Codice base Base code	Potenza Power	Temperatura Temperature	Fascio Beam	Finitura Finishing	Alimentazione Driver
JGE	L 8.4W	A 2700K	C 15°	WW Bianco White	- Driver Remoto Remote Driver
		B 3000K	K 30°	BB Nero Black	
		C 4000K	R 50°		

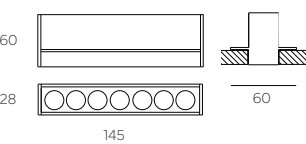

- 0,2 Kg
- 148 mm x 28 mm
- Bianco
White
- Nero
Black
- Finiture custom
Custom finishes

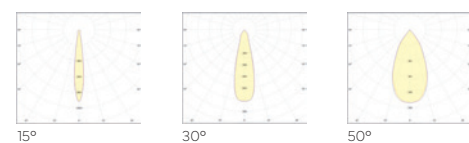

NB: Installabile solo con cartongesso da posare / NB: Only for plasterboard to be installed

Accessori / Accessories

Kit luce di emergenza
Emergency light



kit 1 h 123010
kit 3 h 123023/3

Alimentatore 24V On/Off
Driver 24V On/Off



60 W SL60-24VF
100 W SL100-24VF
150 W SNP150-24VF-1
200 W SL200-24VF

Alimentatore 24V DALI + Push
Driver 24V DALI + Push



60 W SDL60-24VF
100 W SDL100-24VF
150 W SDL150-24VF

Pendants

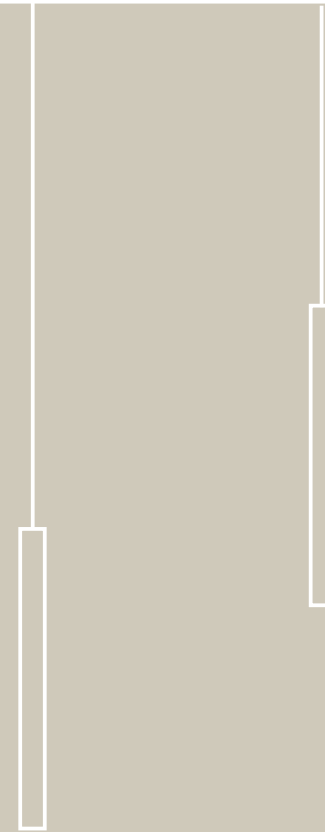



Miniway

Miniway è una lampada a sospensione razionale e minimalista che ridefinisce il modo in cui la luce interagisce con lo spazio, unendo funzionalità ed estetica. Il suo profilo ultrasottile si integra facilmente in qualsiasi ambiente, rendendolo una scelta versatile per uffici, ambienti commerciali e ricettivi.

Miniway is a rational and minimalist pendant luminaire that redefines how light interacts with spaces, blending functionality with aesthetics. Its ultra-thin profile effortlessly integrates into any environment, making it a versatile choice for offices, commercial, and hospitality settings.



Miniway Opal



Up to 23 W

Caratteristiche illuminotecniche / Lighting specs

Watt	Watt LED	mA	IRC/CRI	CCTs	Nom lm	Del lm
/	15 1000 mm	24V	>90	2700K 3000K 4000K	1280 1350 1405	835 878 915
/	23 1500 mm	24V	>90	2700K 3000K 4000K	1920 2025 2108	1248 1315 1370

Codice base Base code	Temperatura Temperature	Potenza Power	Fascio Beam	Finitura Finishing	Alimentazione Driver
7071	Z 2700K	6 24V-15W	Z Diffuse	1 Bianco White	- Non incluso Not included
	7 3000K			2 Nero Black	
	8 4000K				
7072	Z 2700K	6 24V-23W	Z Diffuse	1 Bianco White	- Non incluso Not included
	7 3000K			2 Nero Black	
	8 4000K				

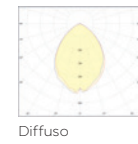
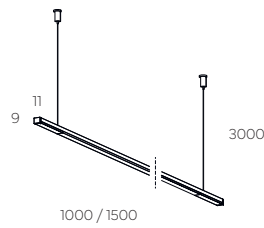

Diffuso

0,2 - 0,4 Kg

Bianco
White

Nero
Black

Finiture custom
Custom finishes



Miniway Opal Bi-emission



Up to 23 W

Caratteristiche illuminotecniche / Lighting specs

Watt	Watt LED	mA	IRC/CRI	CCTs	Nom lm	Del lm
/	15 1000 mm	24V	>90	2700K 3000K 4000K	1280 1350 1405	835 878 915
/	23 1500 mm	24V	>90	2700K 3000K 4000K	1920 2025 2108	1248 1315 1370

Codice base Base code	Temperatura Temperature	Potenza Power	Fascio Beam	Finitura Finishing	Alimentazione Driver
7081	Z 2700K	6 24V-15W	Z Diffuse	1 Bianco White	- Non incluso Not included
	7 3000K			2 Nero Black	
	8 4000K				
7082	Z 2700K	6 24V-23W	Z Diffuse	1 Bianco White	- Non incluso Not included
	7 3000K			2 Nero Black	
	8 4000K				

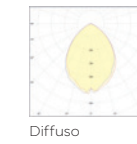
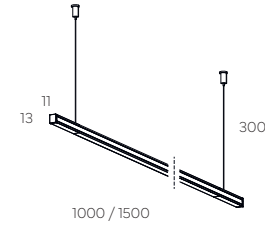

Diffuso

0,3 - 0,5 Kg

Bianco
White

Nero
Black

Finiture custom
Custom finishes



Accessori / Accessories

<p>Rosone + Driver 24V On/Off Ceiling rose + Driver 24V On/Off</p> <p>60W / White KYRO6E1 60W / Black KYRO6E2 280x28x45mm</p>	<p>Rosone + Driver 24V DALI/Push Ceiling rose + Driver 24V DALI/Push</p> <p>60W / White HSRO6D1 60W / Black HSRO6D2 350x40x66mm</p>	<p>Alimentatore 24V On-off Driver 24V On-off</p> <p>60 W SL60-24VF 100 W SL100-24VF</p>	<p>Alimentatore 24V DALI + Push Driver 24V DALI + Push</p> <p>60 W SDL60-24VF 100 W SDL100-24VF</p>	<p>Rosone Semi-Incasso Trim-recessed Canopy</p> <p>White ROSTRIM1 Black ROSTRIM2 Ø 65mm</p>
---	---	---	---	---

Accessori / Accessories

<p>Rosone + Driver 24V On/Off Ceiling rose + Driver 24V On/Off</p> <p>60W / White KYRO6E1 60W / Black KYRO6E2 280x28x45mm</p>	<p>Rosone + Driver 24V DALI/Push Ceiling rose + Driver 24V DALI/Push</p> <p>60W / White HSRO6D1 60W / Black HSRO6D2 350x40x66mm</p>	<p>Alimentatore 24V On-off Driver 24V On-off</p> <p>60 W SL60-24VF 100 W SL100-24VF</p>	<p>Alimentatore 24V DALI + Push Driver 24V DALI + Push</p> <p>60 W SDL60-24VF 100 W SDL100-24VF</p>	<p>Rosone Semi-Incasso Trim-recessed Canopy</p> <p>White ROSTRIM1 Black ROSTRIM2 Ø 65mm</p>
---	---	---	---	---

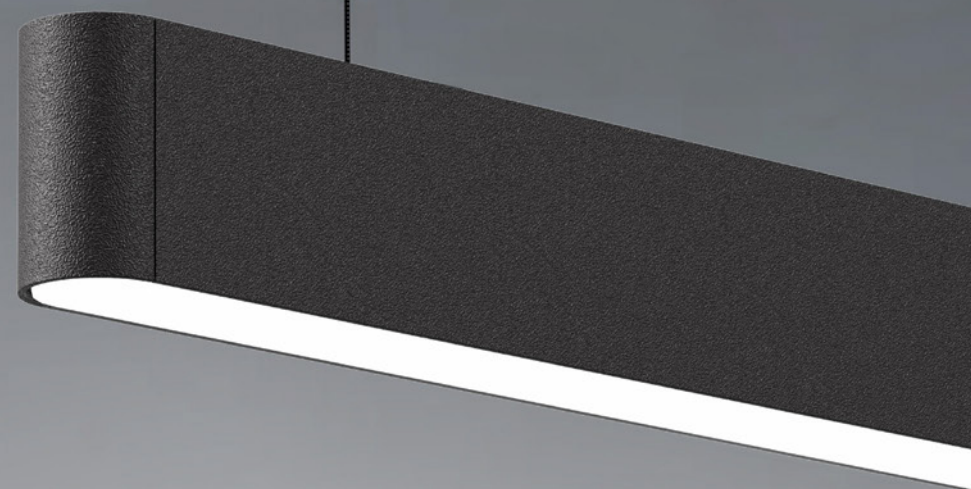

Speedway

Speedway è una sospensione lineare disponibile in due versioni e in varie lunghezze. Il modello opale è ideale per l'illuminazione generale e diffusa. La versione spot è pensata per un'illuminazione più puntale ed è disponibile in tre diversi fasci di luce. Il driver, posizionato all'interno del corpo lampada, rende l'intera struttura più minimale, non necessitando di una driver box esterna. La forma essenziale di Speedway è perfetta per gli interni residenziali, per gli uffici e le postazioni di lavoro.

Speedway is a linear luminaire that comes in two versions and various lengths. The opal model is ideal for general and diffuse lighting. The spot version is designed for focus lighting and it is available in three different light beams. The driver positioned inside the lamp makes the entire structure minimalist, with no need of external driver box. Speedway's essential shape is perfect for residential interiors and various types of offices, conference rooms and workstations.



Speedway Opal



Up to 35 W

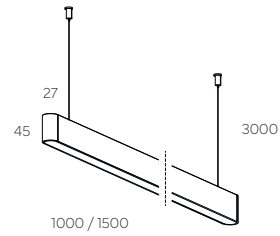

- 1,4 - 2,0 Kg
- Bianco
White
- Nero
Black
- Finiture custom
Custom finishes

Caratteristiche illuminotecniche / Lighting specs

Watt	Watt LED	mA	IRC/CRI	CCTs	Nom lm	Del lm
/	18 1000 mm	24V	>90	2700K 3000K 4000K	1950 2050 2090	1268 1333 1359
/	35 1500 mm	24V	>90	2700K 3000K 4000K	2925 3075 3135	1902 1999 2038

Codice base Base code	Temperatura Temperature	Potenza Power	Fascio Beam	Finitura Finishing	Alimentazione Driver
7011	Z 2700K	6 24V-18W	Z Diffuse	1 Bianco White	E On-Off (Driver integrated)
	7 3000K			L DALI (Driver inside canopy)	
	8 4000K			2 Nero Black	
7012	Z 2700K	6 24V-35W	Z Diffuse	1 Bianco White	E On-Off (Driver integrated)
	7 3000K			L DALI (Driver inside canopy)	
	8 4000K			2 Nero Black	

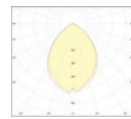

Diffuso

Speedway Excel UGR<19

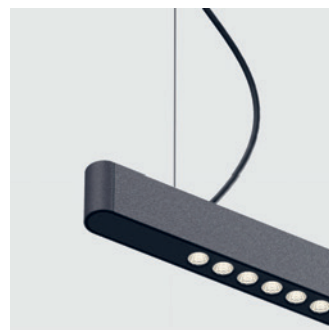

Up to 42 W

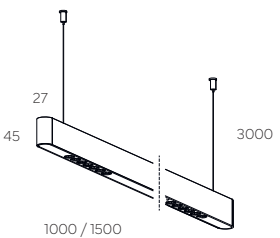

- 1,4 - 2,0 Kg
- Bianco
White
- Nero
Black
- Finiture custom
Custom finishes

Caratteristiche illuminotecniche / Lighting specs

Watt	Watt LED	mA	IRC/CRI	CCTs	Nom lm	Del lm
/	25 1000 mm	24V	>90	2700K 3000K 4000K	3171 3171 3171	2469 2469 2469
/	42 1500 mm	24V	>90	2700K 3000K 4000K	5285 5285 5285	4115 4115 4115

Codice base Base code	Temperatura Temperature	Potenza Power	Fascio Beam	Finitura Finishing	Alimentazione Driver
7021	Z 2700K	6 24V-25W	C 15°	1 Bianco White	E On-Off (Driver integrated)
	7 3000K		K 30°	L DALI (Driver inside canopy)	
	8 4000K		R 50°	2 Nero Black	
7022	Z 2700K	6 24V-42W	C 15°	1 Bianco White	E On-Off (Driver integrated)
	7 3000K		K 30°	L DALI (Driver inside canopy)	
	8 4000K		R 50°	2 Nero Black	

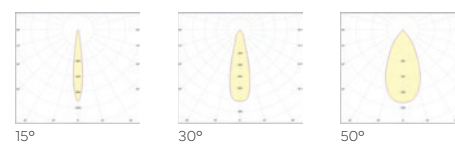

Accessori / Accessories

Rosone + Driver 24V DALI/Push
Ceiling rose + Driver 24V DALI/Push



60W / White HSR06D1
60W / Black HSR06D2
350x40x66mm

Alimentatore 24V DALI + Push
Driver 24V DALI + Push



60 W SDL60-24VF
100 W SDL100-24VF

Rosone Semi-Incasso
Trim-recessed Canopy



White ROSTRIM1
Black ROSTRIM2
Ø 65mm

Speedway Opal Bi-emission



Up to 59 W

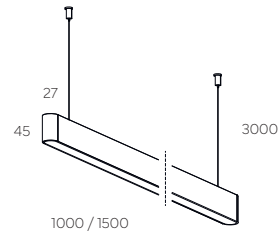

- 1,5 - 2,2 Kg
- Bianco
White
- Nero
Black
- Finiture custom
Custom finishes

Caratteristiche illuminotecniche / Lighting specs

Watt	Watt LED	mA	IRC/CRI	CCTs	Nom lm	Del lm
/	32 1000 mm	24V	>90	2700K 3000K 4000K	1950 +1560 2050 +1640 2090 +1672	1268 +1014 1333 +1066 1359 +1087
/	59 1500 mm	24V	>90	2700K 3000K 4000K	2925 +2730 3075 +2870 3135 +2926	1902 +1775 1999 +1866 2038 +1902

Codice base Base code	Temperatura Temperature	Potenza Power	Fascio Beam	Finitura Finishing	Alimentazione Driver
7031	Z 2700K	6 24V-32W	Z Diffuse	1 Bianco White	- Non incluso Not included
	7 3000K			2 Nero Black	
	8 4000K				
7032	Z 2700K	6 24V-59W	Z Diffuse	1 Bianco White	- Non incluso Not included
	7 3000K			2 Nero Black	
	8 4000K				

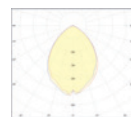

Speedway Excel Bi-emission UGR<19



Up to 66 W

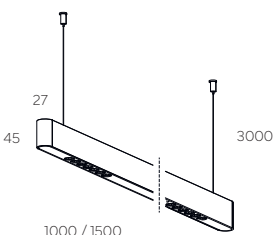

- 1,5 - 2,2 Kg
- Bianco
White
- Nero
Black
- Finiture custom
Custom finishes

Caratteristiche illuminotecniche / Lighting specs

Watt	Watt LED	mA	IRC/CRI	CCTs	Nom lm	Del lm
/	39 1000 mm	24V	>90	2700K 3000K 4000K	3171 +1560 3171 +1640 3171 +1672	2469 +1014 2469 +1066 2469 +1087
/	66 1500 mm	24V	>90	2700K 3000K 4000K	5285 +2730 5285 +2870 5285 +2926	4115 +1775 4115 +1866 4115 +1902

Codice base Base code	Temperatura Temperature	Potenza Power	Fascio Beam	Finitura Finishing	Alimentazione Driver
7041	Z 2700K	6 24V-39W	C 15°	1 Bianco White	- Non incluso Not included
	7 3000K		K 30°	2 Nero Black	
	8 4000K		R 50°		
7042	Z 2700K	6 24V-66W	C 15°	1 Bianco White	- Non incluso Not included
	7 3000K		K 30°	2 Nero Black	
	8 4000K		R 50°		

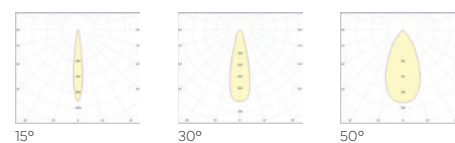

Accessori / Accessories

<p>Rosone + Driver 24V On/Off Ceiling rose + Driver 24V On/Off</p> <p>60W / White KYR06E1 60W / Black KYR06E2 280x28x45mm</p>	<p>Rosone + Driver 24V DALI/Push Ceiling rose + Driver 24V DALI/Push</p> <p>60W / White HSR06D1 60W / Black HSR06D2 350x40x66mm</p>	<p>Alimentatore 24V On-off Driver 24V On-off</p> <p>60 W SL60-24VF 100 W SL100-24VF</p>	<p>Alimentatore 24V DALI + Push Driver 24V DALI + Push</p> <p>60 W SDL60-24VF 100 W SDL100-24VF</p>	<p>Rosone Semi-Incasso Trim-recessed Canopy</p> <p>White ROSTRIM1 Black ROSTRIM2 Ø 65mm</p>
---	---	---	---	---



Subway

Subway è stato realizzato per offrire un'estetica discreta che si integra perfettamente in qualsiasi spazio contemporaneo. Progettato con enfasi sulla semplicità, offre un'esperienza di illuminazione sofisticata che migliora l'atmosfera generale degli ambienti di installazione. Le sue linee eleganti contribuiscono a un'estetica contemporanea e funzionale, emettendo una luce morbida e diffusa, dal grande comfort visivo.

Subway has been crafted to offer a seamless appearance that perfectly integrates to any contemporary space. Designed with a focus on simplicity, it provides a sophisticated lighting experience that enhances the overall atmosphere of any setting. Its elegant lines contribute to a contemporary and functional aesthetic, with a soft, diffused glow and a great visual comfort.



Subway Opal



Up to 35 W

Caratteristiche illuminotecniche / Lighting specs

Watt	Watt LED	mA	IRC/CRI	CCTs	Nom lm	Del lm
/	18 1000 mm	24V	>90	2700K 3000K 4000K	1950 2050 2090	1268 1333 1359
/	35 1500 mm	24V	>90	2700K 3000K 4000K	2925 3075 3135	1902 1999 2038

Codice base Base code	Temperatura Temperature	Potenza Power	Fascio Beam	Finitura Finishing	Alimentazione Driver
7051	Z 2700K	6 24V-18W	Z Diffuse	1 Bianco White	- Non incluso Not included
	7 3000K			2 Nero Black	
	8 4000K				
7052	Z 2700K	6 24V-35W	Z Diffuse	1 Bianco White	- Non incluso Not included
	7 3000K			2 Nero Black	
	8 4000K				

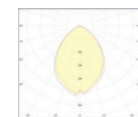

Diffuso

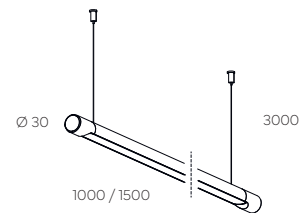

- 1 - 1,5 Kg
- Bianco
White
- Nero
Black
- Finiture custom
Custom finishes

Subway Excel UGR<19



Up to 42 W

Caratteristiche illuminotecniche / Lighting specs

Watt	Watt LED	mA	IRC/CRI	CCTs	Nom lm	Del lm
/	25 1000 mm	24V	>90	2700K 3000K 4000K	3171 3171 3171	2469 2469 2469
/	42 1500 mm	24V	>90	2700K 3000K 4000K	5285 5285 5285	4115 4115 4115

Codice base Base code	Temperatura Temperature	Potenza Power	Fascio Beam	Finitura Finishing	Alimentazione Driver
7061	Z 2700K	6 24V-25W	C 15°	1 Bianco White	- Non incluso Not included
	7 3000K		K 30°	2 Nero Black	
	8 4000K		R 50°		
7062	Z 2700K	6 24V-42W	C 15°	1 Bianco White	- Non incluso Not included
	7 3000K		K 30°	2 Nero Black	
	8 4000K		R 50°		

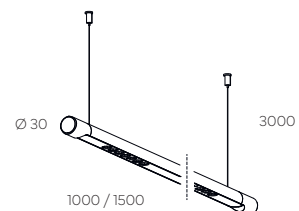
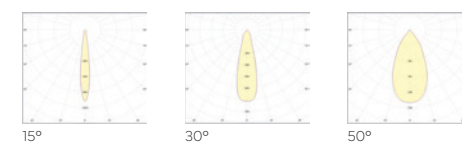

- 1 - 1,5 Kg
- Bianco
White
- Nero
Black
- Finiture custom
Custom finishes

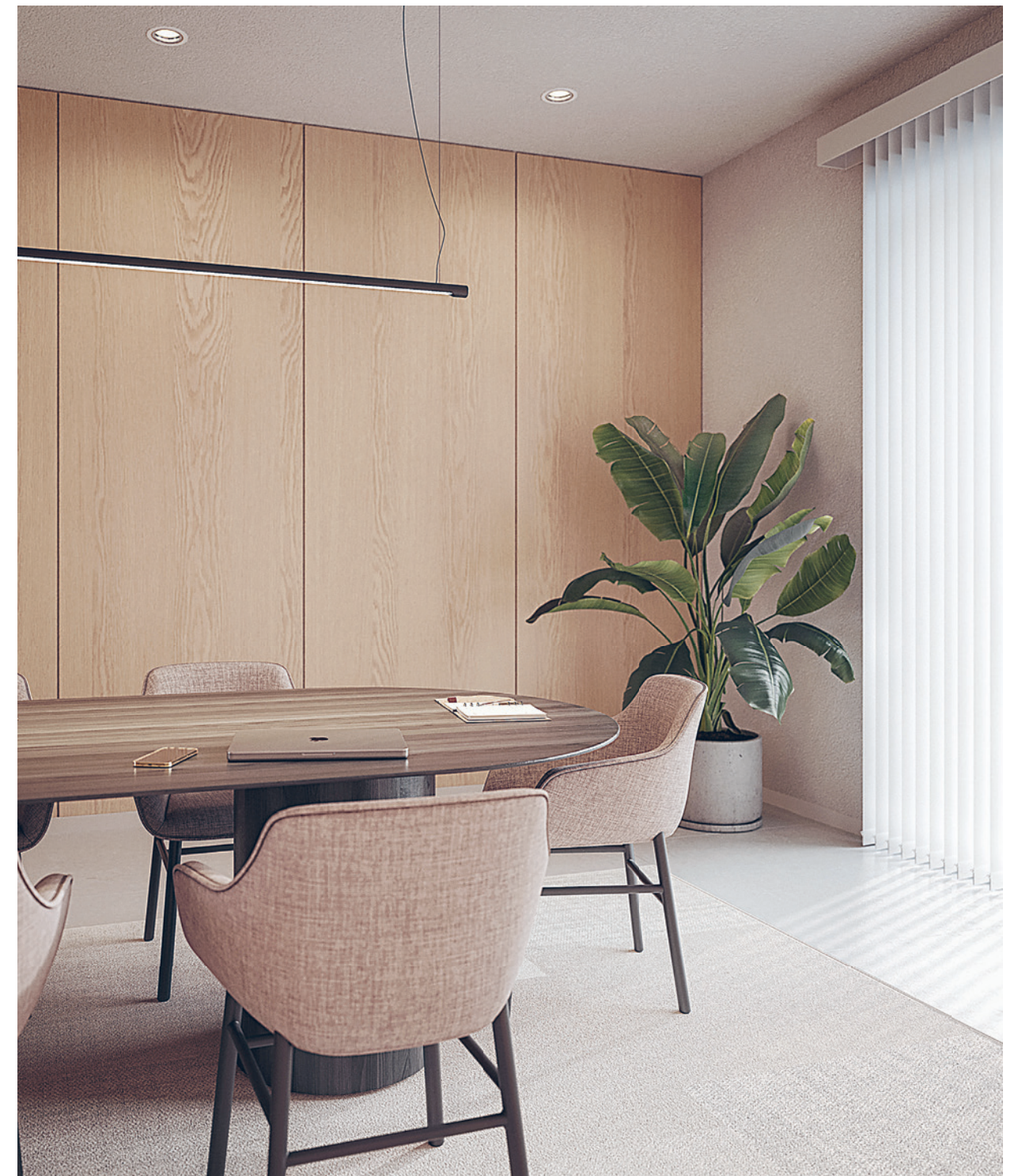

Accessori / Accessories

<p>Rosone + Driver 24V On/Off Ceiling rose + Driver 24V On/Off</p> <p>60W / White KYR06E1 60W / Black KYR06E2 280x28x45mm</p>	<p>Rosone + Driver 24V DALI/Push Ceiling rose + Driver 24V DALI/Push</p> <p>60W / White HSR06D1 60W / Black HSR06D2 350x40x66mm</p>	<p>Alimentatore 24V On-off Driver 24V On-off</p> <p>60 W SL60-24VF 100 W SL100-24VF</p>	<p>Alimentatore 24V DALI + Push Driver 24V DALI + Push</p> <p>60 W SDL60-24VF 100 W SDL100-24VF</p>	<p>Rosone Semi-Incasso Trim-recessed Canopy</p> <p>White ROSTRIM1 Black ROSTRIM2 Ø 65mm</p>
---	---	---	---	---



Candle

Candle nasce per creare composizioni sospese, dinamiche e versatili, ed è ideale per spazi con grandi altezze. Disponibile in diverse lunghezze, il sistema è dotato di rosone a plafone o a semi-incasso e può essere regolato a diverse altezze, definibili in fase di installazione.

Candle is designed for dynamic and versatile suspended compositions and it's ideal for spaces with great heights. Available in different lengths, the system is equipped with a ceiling rose or semi-recessed ceiling rose and can be adjusted to different heights, which can be defined during installation.

Candle



Up to
90 W

Caratteristiche illuminotecniche / Lighting specs

Watt	Watt LED	mA	IRC/CRI	CCTs	Nom lm	Del lm
/	30 1000 mm	24V	>90	2700K 3000K 4000K	2560 2700 2810	1664 1755 1827
/	45 1500 mm	24V	>90	2700K 3000K 4000K	3840 4050 4215	2496 2633 2740
/	60 2000 mm	24V	>90	2700K 3000K 4000K	5120 5400 5620	3328 3510 3653
/	75 2500 mm	24V	>90	2700K 3000K 4000K	6400 6750 7025	4160 4388 4566
/	90 3000 mm	24V	>90	2700K 3000K 4000K	7680 8100 8430	4992 5265 5480

Codice base Base code	Temperatura Temperature	Potenza Power	Fascio Beam	Finitura Finishing	Alimentazione Driver
7101	Z 2700K	6 30W 1000 mm	Z Diffuse	1 Bianco White	- Non incluso Not included
	7 3000K			2 Nero Black	
	8 4000K				
7102	Z 2700K	6 45W 1500 mm	Z Diffuse	1 Bianco White	- Non incluso Not included
	7 3000K			2 Nero Black	
	8 4000K				
7103	Z 2700K	6 60W 2000 mm	Z Diffuse	1 Bianco White	- Non incluso Not included
	7 3000K			2 Nero Black	
	8 4000K				
7104	Z 2700K	6 75W 2500 mm	Z Diffuse	1 Bianco White	- Non incluso Not included
	7 3000K			2 Nero Black	
	8 4000K				
7105	Z 2700K	6 90W 3000 mm	Z Diffuse	1 Bianco White	- Non incluso Not included
	7 3000K			2 Nero Black	
	8 4000K				

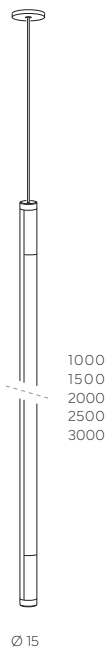

0,3 - 1 Kg

Bianco
White

Nero
Black

Finiture custom
Custom finishes

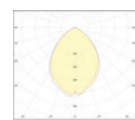

Diffuso



Accessori / Accessories

Alimentatore 24V On/Off
Driver 24V On/Off



60 W SL60-24VF
100 W SL100-24VF
150 W SNP150-24VF-1
200 W SL200-24VF

Alimentatore 24V DALI + Push
Driver 24V DALI + Push



60 W SDL60-24VF
100 W SDL100-24VF
150 W SDL150-24VF

Rosone Semi-Incasso
Trim-recessed Canopy



White ROSTRIM1
Black ROSTRIM2
Ø 65mm





Cycle

Cycle è una lampada a sospensione circolare minimale. Il suo punto di forza è il profilo estremamente sottile. L'apparecchio può essere installato verticalmente o orizzontalmente e la sua presenza discreta aggiunge un tocco di raffinatezza a qualsiasi spazio.

Cycle is a minimalist circular pendant lamp. Its ultra-slim profile represents its plus. The luminaire can be installed vertically or horizontally and its discreet presence adds a touch of sophistication to any space.

Cycle



Up to 85 W

Caratteristiche illuminotecniche / Lighting specs

Watt	Watt LED	mA	IRC/CRI	CCTs	Nom lm	Del lm
/	28 Ø600 mm	24V	>90	2700K 3000K 4000K	2420 2552 2656	1573 1659 1727
/	46 Ø1000 mm	24V	>90	2700K 3000K 4000K	4020 4239 4412	2613 2755 2868
/	64 Ø1400 mm	24V	>90	2700K 3000K 4000K	5632 5940 6182	3661 3861 4018
/	82 Ø1800 mm	24V	>90	2700K 3000K 4000K	7232 7628 7938	4701 4958 5160

Codice base Base code	Temperatura Temperature	Potenza Power	Fascio Beam	Finitura Finishing	Alimentazione Driver
7091 Ø600 mm	Z 2700K 7 3000K 8 4000K	6 28W	Z Diffuse	1 Bianco White 2 Nero Black	- Non incluso Not included
7092 Ø1000 mm	Z 2700K 7 3000K 8 4000K	6 46W	Z Diffuse	1 Bianco White 2 Nero Black	- Non incluso Not included
7093 Ø1400 mm	Z 2700K 7 3000K 8 4000K	6 64W	Z Diffuse	1 Bianco White 2 Nero Black	- Non incluso Not included
7094 Ø1800 mm	Z 2700K 7 3000K 8 4000K	6 82W	Z Diffuse	1 Bianco White 2 Nero Black	- Non incluso Not included

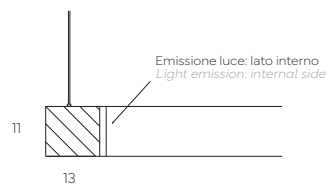
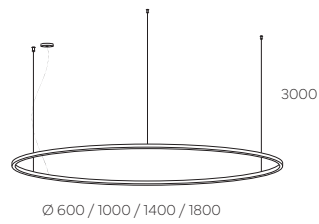

NB: Su richiesta Cycle può essere predisposto per installazione con orientamento verticale
NB: Cycle can be set-up to stand vertically on request.

0,5 - 1,7 Kg

Bianco
White
Nero
Black

Finiture custom
Custom finishes

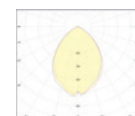

Diffuso

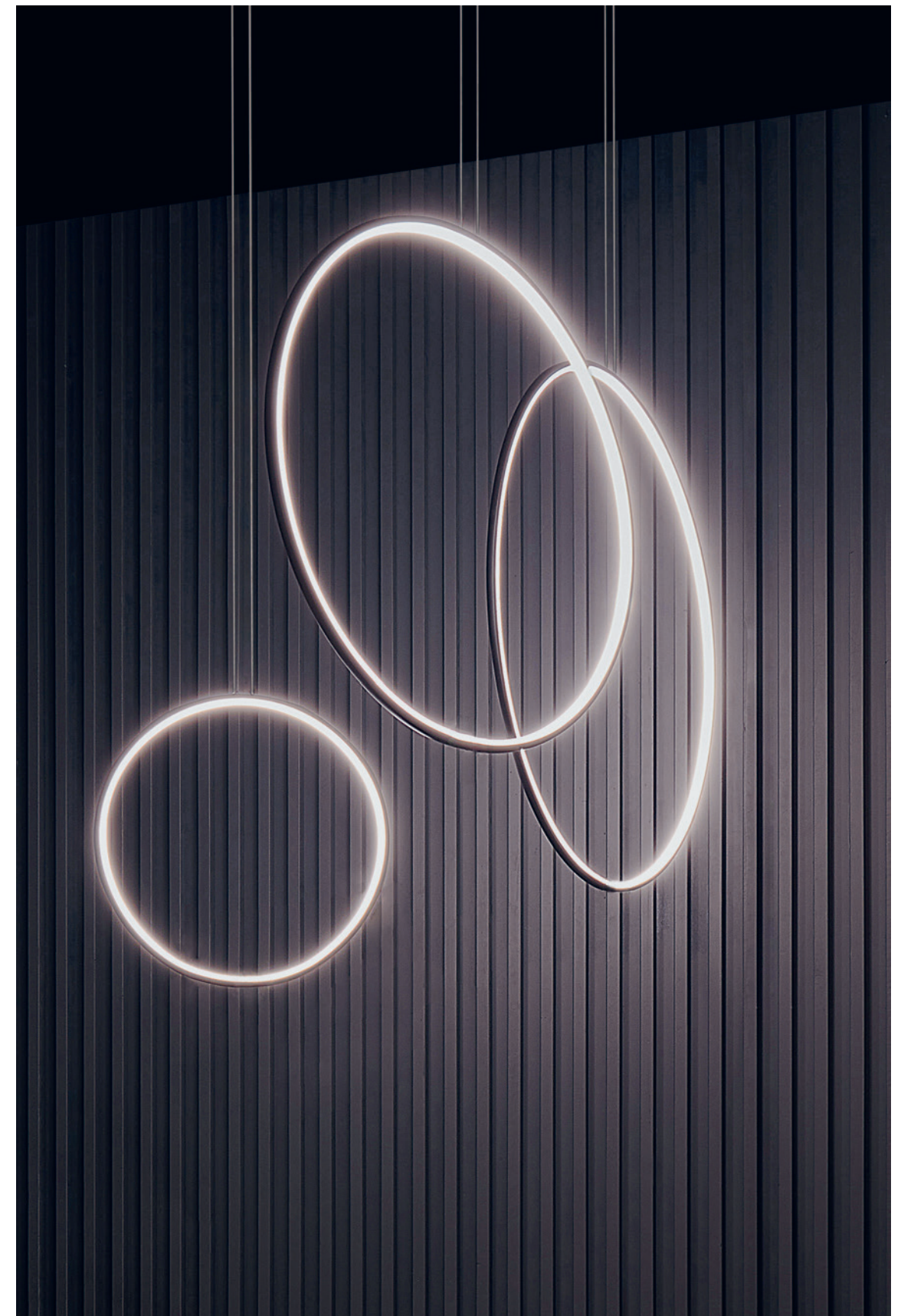

Accessori / Accessories

Alimentatore 24V On/Off
Driver 24V On/Off



60 W SL60-24VF
100 W SL100-24VF
150 W SNP150-24VF-1
200 W SL200-24VF

Alimentatore 24V DALI + Push
Driver 24V DALI + Push



60 W SDL60-24VF
100 W SDL100-24VF
150 W SDL150-24VF

Rosone + Alimentatore 24V On/Off
Canopy + Driver 24V On/Off



60 W / White CYRO6E1
60 W / Black CYRO6E2
100W / White CYRO1E1
100W / White CYRO1E2
Ø 200 mm

Rosone Semi-Incasso
Trim-recessed Canopy



White ROSTRIM1
Black ROSTRIM2
Ø 65mm



Ice

Questa versione del prodotto Ice è pensata per installazioni stand-alone. Grazie alla possibilità di rosone semi-incassato, questa soluzione si distingue per l'impatto estetico minimale e può valorizzare superfici come banchi di reception o tavoli espositivi.

This version of Ice product is designed for stand-alone installations. Thanks to the trim-recessed ceiling rose option, this solution has a minimalist aesthetic impact and can enhance surfaces such as reception desks or display tables.

Ice



2 W

Caratteristiche illuminotecniche / Lighting specs

Watt	Watt LED	mA	IRC/CRI	CCTs	Nom lm	Del lm
2	1.7	350	>90	2700K	195	162
				3000K	195	162
				3500K	195	162
				4000K	195	162

Codice base Base code	Temperatura Temperature	Potenza Power	Fascio Beam	Finitura Finishing	Alimentazione Driver
1168	Z 2700K	B 2W	G 25°	1 Bianco	E On-Off
	7 3000K		N 40°	White	L DALI
	0 3500K		T 60°	2 Nero	
	8 4000K		1 80°	Black	

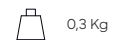
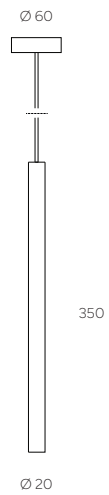

0,3 Kg



Bianco
White



Nero
Black



Finiture custom
Custom finishes

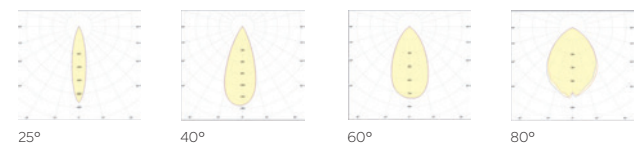

Accessori / Accessories

Kit luce di emergenza
Emergency light



kit 1 h 123010
kit 3 h 123023/3

Alimentatore 24V On/Off
Driver 24V On/Off



60 W SL60-24VF
100 W SL100-24VF
150 W SNP150-24VF-1
200 W SL200-24VF

Alimentatore 24V DALI + Push
Driver 24V DALI + Push



60 W SDL60-24VF
100 W SDL100-24VF
150 W SDL150-24VF

Rosone + Alimentatore 24V On/Off
Canopy + Driver 24V On/Off



60 W / White CYRO6E1
60 W / Black CYRO6E2
100W / White CYRO1E1
100W / White CYRO1E2
Ø 200 mm

Rosone Semi-Incasso
Trim-recessed Canopy



White ROSTRIM1
Black ROSTRIM2
Ø 65mm

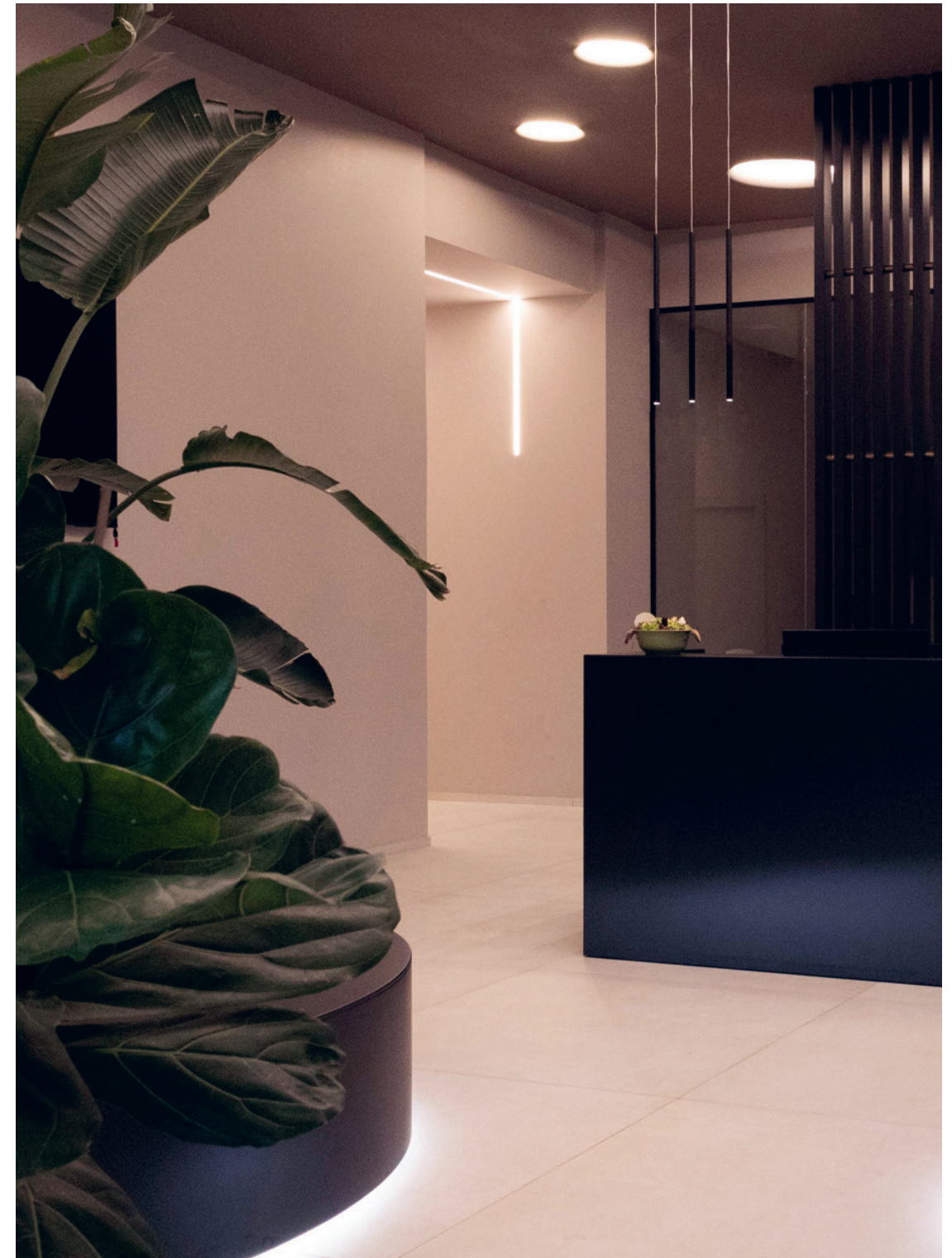



KS

KS è una sospensione cilindrica dalle forme essenziali. Grazie all'alimentazione diretta in tensione di rete, non presenta limitazioni nell'installazione. Progettata per assicurare prestazioni ottimali, garantisce adeguati valori di illuminamento sulle superfici di lavoro, senza compromettere l'estetica degli ambienti.

KS is a cylindrical ceiling luminaire with an essential design. Thanks to its internal 230V power supply, it has no installation limitations. Designed for optimal performance, it ensures adequate luminance values on the work surfaces without compromising the aesthetics of the rooms.

KS



Up to
18 W

Caratteristiche illuminotecniche / Lighting specs

Watt	Watt LED	mA	IRC/CRI	CCTs	Nom lm	Del lm
12	11.8	350	>90	2700K	1539	1179
				3000K	1618	1239
				4000K	1700	1302
18	17.4	500	>90	2700K	2124	1627
				3000K	2235	1712
				4000K	2347	1798

Codice base Base code	Temperatura Temperature	Potenza Power	Fascio Beam	Finitura Finishing	Alimentazione Driver
2018	Z 2700K	B 12W	B 12°	1 Bianco White	E On-Off
	7 3000K	C 18W	F 24°	2 Nero Black	L DALI
	8 4000K		M 38°		C Casambi
			T 60°		

* A richiesta è possibile configurare il prodotto con LED speciali e temperature colore dedicate.
Special LEDs and specific colour temperatures can be configured on request.

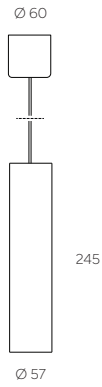

0,3 Kg

- Bianco
White
- Nero
Black
- Finiture custom
Custom finishes

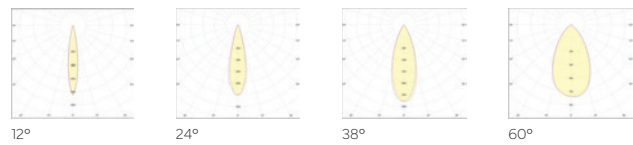

P20
48 V CV
RG1
CE
T_a 25 °C
355°
90°
Optional SunLike
5 years Warranty up to



Accessori / Accessories

Rosone Semi-Incasso
Trim-recessed Canopy



White ROSTRIM1
Black ROSTRIM2
Ø 65mm

Frangiluce
Honeycomb

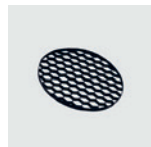

Magic K/XS KSGRI

Lenti
Lenses

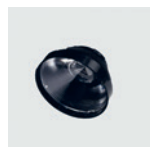

Magic K/XS

12° 202512
24° 202524
38° 202538
60° 202560



HS

HS è un sistema componibile di profili a sospensione con driver integrato, disponibile con tre tipologie di sorgenti luminose: opale, microprismato e proiettori orientabili. Grazie agli appositi accessori, è possibile creare composizioni personalizzate e percorsi di luce.

HS is a modular system of suspension profiles with integrated driver, available with 3 types of light sources: opal, micro-prismatic and adjustable projectors. Thanks to dedicated accessories, custom compositions and light paths can be created.

HS



Up to 36.4W

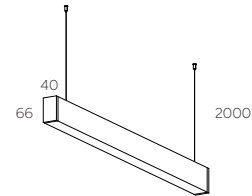

- 568 / 848 / 1128 / 1408 / 1688 / 1968 mm
- 2,5 Kg
- Bianco White, Nero Black, Finiture custom Custom finishes

Caratteristiche illuminotecniche / Lighting specs

Watt	Watt LED	mA	IRC/CRI	CCTs	Nom lm	Del lm
14	10.4	500 mA	>90	3000K 4000K	1700 1810	1040 1108
20	15.6	500 mA	>90	3000K 4000K	2550 2715	1561 1662
25	20.8	500 mA	>90	3000K 4000K	3400 3620	2081 2215
31	26	500 mA	>90	3000K 4000K	4250 4525	2601 2769
36	31.2	500 mA	>90	3000K 4000K	5100 5430	3121 3323
41	36.4	500 mA	>90	3000K 4000K	5950 6335	3642 3877

Codice base Base code	Schermo Diffuser	Potenza / Lunghezza Power / Lenght	Temperatura Temperature	Finitura Finishing	Alimentazione Driver
HS	O Opal	0560 10.4 w / 568 mm	3K 3000K	1 Bianco White	E On/Off
	T UGR<19	0840 15.6 w / 848 mm	4K 4000K	2 Nero Black	L DALI
		1120 20.8 w / 1128 mm			
		1400 26 w / 1408 mm			
		1680 31.2 w / 1688 mm			
		1960 36.4 w / 1968 mm			

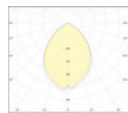

Diffuso



HS Spot



Up to 27 W

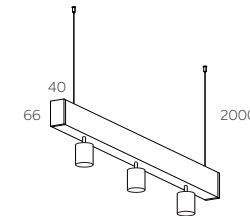

- 1128 mm
- 3,2 Kg
- Bianco White, Nero Black, Finiture custom Custom finishes

Caratteristiche illuminotecniche / Lighting specs

Watt	Watt LED	mA	IRC/CRI	CCTs	Nom lm	Del lm
27	3 x 8 W	900 mA	>90	3000K 4000K	3372 3546	2583 2715

Codice base Base code	Schermo Diffuser	Potenza / Lunghezza Power / Lenght	Temperatura Temperature	Finitura Finishing	Alimentazione Driver
HS	S Spot	1120 3 x 8W 24° / 1128 mm	3K 3000K 4K 4000K	1 Bianco White 2 Nero Black	E On/Off L DALI

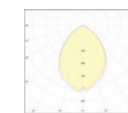

Diffuso



HS Bi-emission



Up to 67 W

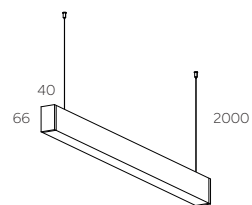

- 1128 / 1408 / 1688 / 1968 mm
- 1,3 - 5,2 Kg
- Bianco White, Nero Black, Finiture custom Custom finishes

Caratteristiche illuminotecniche / Lighting specs

Watt	Watt LED	mA	IRC/CRI	CCTs	Nom lm	Del lm
34	20.8 + 10.4	500 mA	>90	3000K 4000K	3400 + 1700 3620 + 1810	2081 + 1040 2215 + 1108
45	26 + 15.6	500 mA	>90	3000K 4000K	4250 + 2550 4525 + 2715	2601 + 1561 2769 + 1662
56	31.2 + 20.8	500 mA	>90	3000K 4000K	5100 + 3400 5430 + 3620	3121 + 2081 3323 + 2215
67	36.4 + 26	500 mA	>90	3000K 4000K	5950 + 4250 6335 + 4525	3642 + 2601 3877 + 2769

Codice base Base code	Schermo Diffuser	Potenza / Lunghezza Power / Lenght	Temperatura Temperature	Finitura Finishing	Alimentazione Driver
HS	O Opal	112B 20.8 w + 10.4 w / 1128 mm	3K 3000K	1 Bianco White	E On/Off
	T UGR<19	140B 26 w + 15.6 w / 1408 mm	4K 4000K	2 Nero Black	L DALI
		168B 31.2 w + 20.8 w / 1688 mm			
		196B 36.4 w + 31.2 w / 1968 mm			

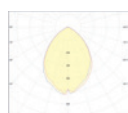

Diffuso



HS L-Joint



20.8W

Caratteristiche illuminotecniche / Lighting specs						
Watt	Watt LED	mA	IRC/CRI	CCTs	Nom lm	Del lm
25	20.8	500 mA	>90	3000 4000	3400 3620	2081 2215

Codice base Base code	Schermo Diffuser	Potenza / Lunghezza Power / Lenght	Temperatura Temperature	Finitura Finishing	Alimentazione Driver
HS	O Opal T UGR<19 I Blind	A560 20.8 w / 592 + 592 mm	3K 3000K 4K 4000K 00 Blind	1 Bianco White 2 Nero Black	E On/Off L DALI - Blind

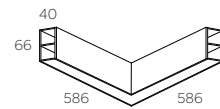

- 2,2 Kg
- Bianco
White
- Nero
Black
- Finiture custom
Custom finishes

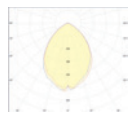

Diffuso



HS X-Joint



20.8W

Caratteristiche illuminotecniche / Lighting specs						
Watt	Watt LED	mA	IRC/CRI	CCTs	Nom lm	Del lm
25	20.8	500 mA	>90	3000 4000	3400 3620	2081 2215

Codice base Base code	Schermo Diffuser	Potenza / Lunghezza Power / Lenght	Temperatura Temperature	Finitura Finishing	Alimentazione Driver
HS	O Opal T UGR<19 I Blind	X560 20.8 w / 592 + 592 mm	3K 3000K 4K 4000K 00 Blind	1 Bianco White 2 Nero Black	E On/Off L DALI - Blind

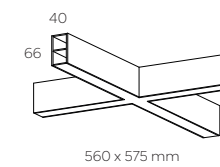

- 2,6 Kg
- Bianco
White
- Nero
Black
- Finiture custom
Custom finishes

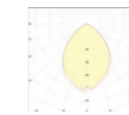

Diffuso



HST-Joint

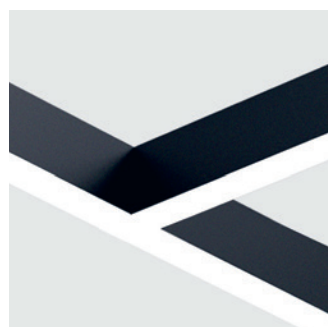

20.8W

Caratteristiche illuminotecniche / Lighting specs						
Watt	Watt LED	mA	IRC/CRI	CCTs	Nom lm	Del lm
25	20.8	500 mA	>90	3000 4000	3400 3620	2081 2215

Codice base Base code	Schermo Diffuser	Potenza / Lunghezza Power / Lenght	Temperatura Temperature	Finitura Finishing	Alimentazione Driver
HS	O Opal T UGR<19 I Blind	T560 20.8 w / 592 + 592 mm	3K 3000K 4K 4000K 00 Blind	1 Bianco White 2 Nero Black	E On/Off L DALI - Blind

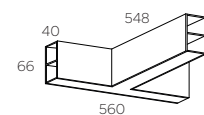

- 2,2 Kg
- Bianco
White
- Nero
Black
- Finiture custom
Custom finishes

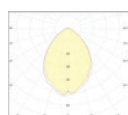

Diffuso



Accessori / Accessories



Giunto Meccanico Lineare /
Linear Mechanical Joint



HSKIT01



Rosone / Ceiling rose



ROSE50W



ROSE50B



Tappo di Chiusura /
End-cap



HSTW



HSTB



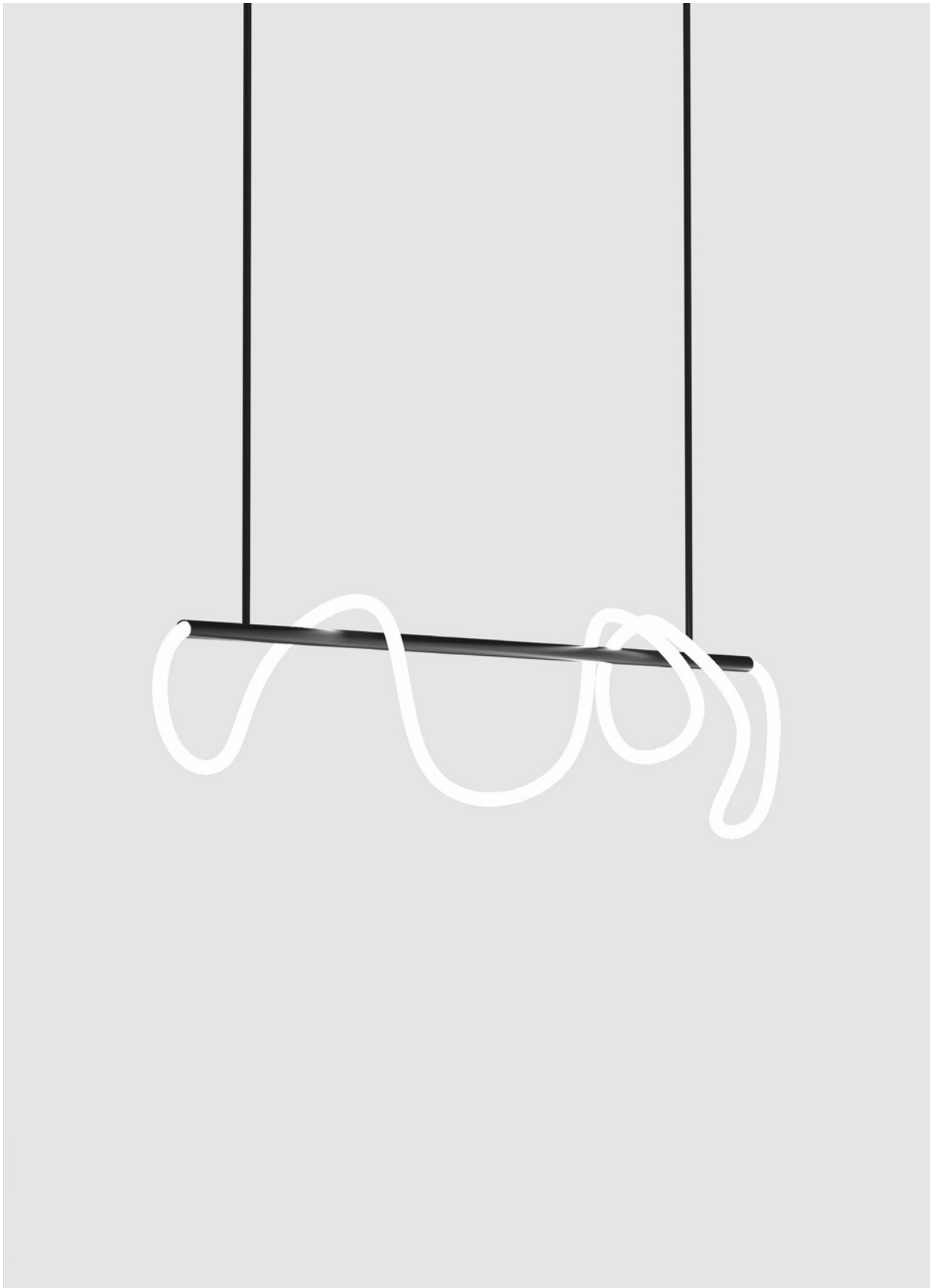

Snake

Snake è un prodotto lineare a sospensione modellabile in base alle necessità progettuali. Grazie alla sorgente luminosa siliconica, Snake permette di creare composizioni di luce di diverse forme, personalizzando così la propria installazione.

Snake is a linear pendant lamp that can be modeled according to design requirements. Thanks to its silicone light source, Snake allows you to create light compositions of different shapes, thus customising your installation.

Snake

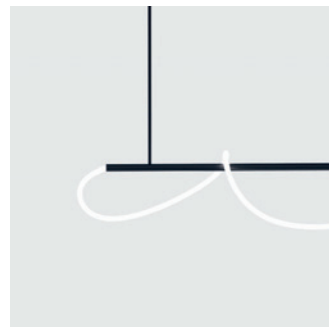

Up to
72 W

Caratteristiche illuminotecniche / Lighting specs

Watt	Watt LED	mA	IRC/CRI	CCTs	Nom lm	Del lm
/	72	24V	>90	2700K	/	4750
	5000 mm			3000K	/	4750
				4000K	/	4750

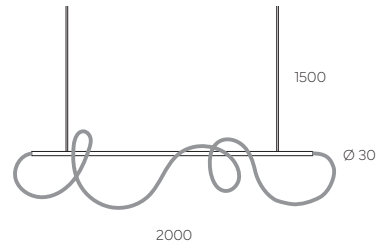

Codice base Base code	Temperatura Temperature	Potenza Power	Fascio Beam	Finitura Finishing	Alimentazione Driver
7111	Z 2700K 7 3000K 8 4000K	6 24V-72W	Z Diffuse	1 Bianco 2 Nero	Non incluso Not included

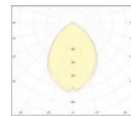

Diffuso

6,2 Kg

Bianco
White

Nero
Black

Finiture custom
Custom finishes

IP20



24 V
CV

RG0

CE

Ta
25 °C

5 years
Warranty up to



Accessori / Accessories

Alimentatore 24V On-off
Driver 24V On-off



60 W SL60-24VF
100 W SL100-24VF

Alimentatore 24V DALI + Push
Driver 24V DALI + Push



60 W SDL60-24VF
100 W SDL100-24VF

Rosone Semi-Incasso
Trim-recessed Canopy



ROSTRIM
Ø 60 mm

Wall

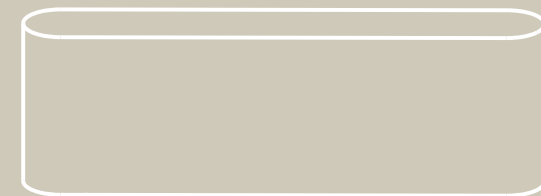



Speedway Wall

Speedway in versione a parete mantiene le stesse linee curve ed essenziali della sospensione. La variante con modulo Excel è pensata per un fascio luminoso pulito e definito. La variante opale garantisce un'illuminazione diffusa e omogenea. L'alimentatore è integrato nel corpo lampada e le staffe per il fissaggio a parete sono invisibili.

The Speedway Wall retains the same curved and essential lines as the pendant version. The Excel version is designed to provide a clean, defined beam of light. The Opal version provides diffused light for a homogeneous illumination. The driver is integrated into the body and the wall brackets are invisible.

Speedway Wall Opal



6 W

Caratteristiche illuminotecniche / Lighting specs

Watt	Watt LED	mA	IRC/CRI	CCTs	Nom lm	Del lm
/	6	24V	>90	2700K	585	380
				3000K	615	400
				4000K	627	408
/	10	24V	>90	2700K	975	633
				3000K	1030	667
				4000K	1045	680

Codice base Base code	Temperatura Temperature	Potenza Power	Fascio Beam	Finitura Finishing	Alimentazione Driver
4010	Z 2700K	6 24V	Z Diffuse	1 Bianco White	E On-Off (integrated) - Not included
	7 3000K			2 Nero Black	
	8 4000K				
4011	Z 2700K	6 24V	Z Diffuse	1 Bianco White	E On-Off (integrated) - Not included
	7 3000K			2 Nero Black	
	8 4000K				



300 (mod. 4010)
500 (mod. 4011)



0,5 Kg



Bianco
White



Nero
Black



Finiture custom
Custom finishes

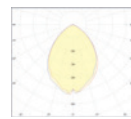

Diffuso



Speedway Wall Excel UGR<19



8.4 W

Caratteristiche illuminotecniche / Lighting specs

Watt	Watt LED	mA	IRC/CRI	CCTs	Nom lm	Del lm
/	8.4	24V	>90	2700K	1057	823
				3000K	1057	823
				4000K	1057	823

Codice base Base code	Temperatura Temperature	Potenza Power	Fascio Beam	Finitura Finishing	Alimentazione Driver
4020	Z 2700K	6 24V	C 15°	1 Bianco White	E On-Off (integrated) - Not included
	7 3000K		K 30°	2 Nero Black	
	8 4000K		R 50°		

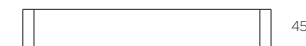

300



0,6 Kg



Bianco
White



Nero
Black



Finiture custom
Custom finishes

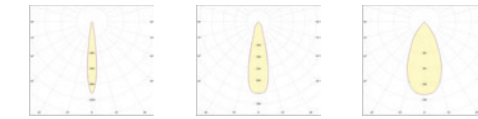

15°

30°

50°



Accessori / Accessories

Kit luce di emergenza
Emergency light



kit 1 h 123010
kit 3 h 123023/3

Alimentatore 24V On/Off
Driver 24V On/Off



60 W SL60-24VF
100 W SL100-24VF
150 W SNP150-24VF-1
200 W SL200-24VF

Alimentatore 24V DALI + Push
Driver 24V DALI + Push



60 W SDL60-24VF
100 W SDL100-24VF
150 W SDL150-24VF

Accessori / Accessories

Kit luce di emergenza
Emergency light



kit 1 h 123010
kit 3 h 123023/3

Alimentatore 24V On/Off
Driver 24V On/Off



60 W SL60-24VF
100 W SL100-24VF
150 W SNP150-24VF-1
200 W SL200-24VF

Alimentatore 24V DALI + Push
Driver 24V DALI + Push



60 W SDL60-24VF
100 W SDL100-24VF
150 W SDL150-24VF



Laser Wall

Il segna-passo lineare Laser Wall è disponibile in varie lunghezze e può essere montato su pareti in cartongesso o, mediante un apposito accessorio, su superfici in cemento. Dotato di contro-cassa per l'installazione, permette una facile manutenzione nel tempo. Grazie all'alimentazione a 24V, consente il collegamento in parallelo per ridurre al minimo la presenza di alimentatori e semplificare il collegamenti elettrici.



Laser Wall is a linear step marker available in different lengths. It can be mounted on plasterboard walls or on concrete surfaces, by using a special accessory. Equipped with a metal housing for installation, it allows easy maintenance over time. Thanks to its 24V power supply, it can be connected in parallel to minimize the use of drivers and simplify electrical connections.

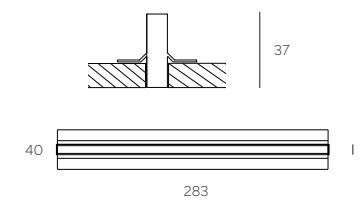

Laser Wall

2.8 W



-  0,2 Kg
-  285 x 11 mm
- 
 - Bianco
White
 - Nero
Black

Caratteristiche illuminotecniche / Lighting specs

Watt	Watt LED	mA	IRC/CRI	CCTs	Nom lm	Del lm
/	2.8	24V	>90	2700K 3000K 4000K	310 310 310	170 170 170

Codice base Base code	Temperatura Temperature	Potenza Power	Fascio Beam	Finitura Finishing	Alimentazione Driver
4030	Z 2700K 7 3000K 8 4000K	6 24V	Z Diffuso	7 Alluminio Aluminium	- Not included

*Installabile solo con cartongesso da posare / Only for plasterboard to be installed

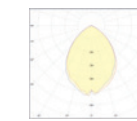

Diffuso







Accessori / Accessories

Kit luce di emergenza
Emergency light



kit 1 h 123010
kit 3 h 123023/3

Alimentatore 24V On/Off
Driver 24V On/Off



60 W SL60-24VF
100 W SL100-24VF
150 W SNP150-24VF-1
200 W SL200-24VF

Alimentatore 24V DALI + Push
Driver 24V DALI + Push



60 W SDL60-24VF
100 W SDL100-24VF
150 W SDL150-24VF

Kit installazione calcestruzzo
Concrete Kit

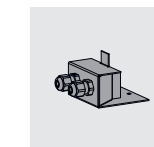

KHBOX

LED strips & profiles

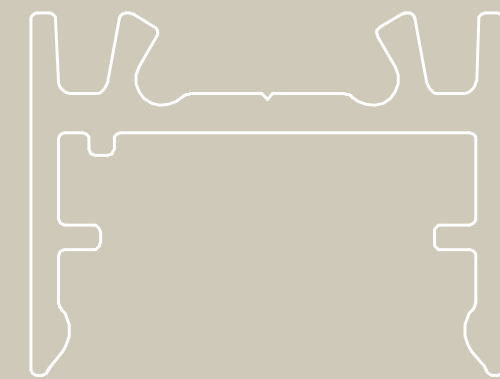



MA - Surface





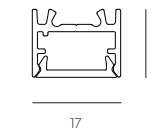





Profilo in alluminio estruso completo di schermo in policarbonato opale anti-UV. Installazione a plafone
 Aluminium extruded profile with anti-UV opal polycarbonate diffuser. Ceiling installation



Codice base Base code	Lunghezza mm Length mm		Colore Finishes	Peso Kg Weight Kg
MAO	100	1000	W Bianco / White	0,15 kg
	200	2000	B Nero / Black	0,31 kg
	300	3000	A Anodized	0,46 kg

Accessori / Accessories

 Tappo di chiusura / End cap	 MATW MATB MATA	 Staffa di fissaggio trimless / Trimless fixing clip	 MASW MASB MASA
 Staffa di fissaggio a plafone - Giunto lineare / Ceiling fixing clip - Linear connector	 SAMW SAMB SAMA	 Magnete per fissaggio a soffitto / Ceiling fixing magnet	 SAMAG

MC - Trim Recessed





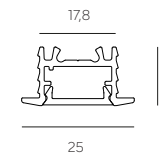



Profilo in alluminio estruso completo di schermo in policarbonato opale anti-UV. Installazione a incasso con bordo
 Aluminium extruded profile with anti-UV opal polycarbonate diffuser. Trim recessed installation



Codice base Base code	Lunghezza mm Length mm		Colore Finishes	Peso Kg Weight Kg
MCO	100	1000	W Bianco / White	0,19 kg
	200	2000	B Nero / Black	0,38 kg
	300	3000	A Anodized	0,58 kg

Accessori / Accessories

 Tappo di chiusura / End cap	 MCTW MCTB MCTA	 Molla di fissaggio / Fixing spring	 SCM
 Giunto lineare meccanico / Linear mechanical joint	 SAMW SAMB SAMA		

MJ - Trimless Recessed

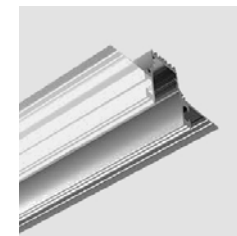

Profilo in alluminio estruso completo di schermo in policarbonato opale anti-UV. Installazione a incasso senza bordo
 Aluminium extruded profile with anti-UV opal polycarbonate diffuser. Trimless recessed installation

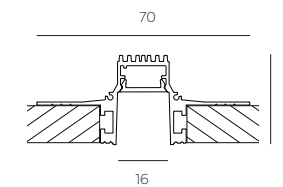

Codice base Base code	Lunghezza mm Length mm		Colore Finishes	Peso Kg Weight Kg
MJO	100	1000	W Bianco / White	0,65 kg
	200	2000	B Nero / Black	1,30 kg
	300	3000	A Anodized	1,95 kg

Accessori / Accessories

 Tappo di chiusura / End cap	 MJTW MJTB MJTA	 Giunto lineare meccanico / Linear mechanical joint	 JAKIT02
---	--	--	---

Ilmas

ME - 45° Corner

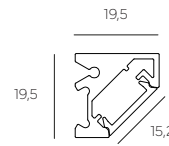

Codice base Base code	Lunghezza mm Length mm	Colore Finishes	Peso Kg Weight Kg
MEO	100 1000	W Bianco / White	0,37 kg
	200 2000	B Nero / Black	0,74 kg
	300 3000	A Anodized	1,10 kg

Profilo in alluminio estruso completo di schermo in policarbonato opale anti-UV. Installazione angolare
 Aluminium extruded profile with anti-UV opal polycarbonate diffuser. Corner installation

Accessori / Accessories

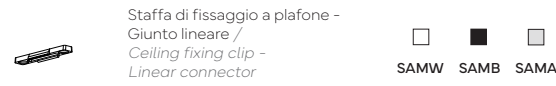
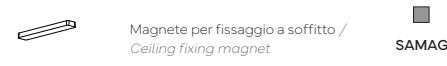

MP - Trimless Atmosphere Lighting

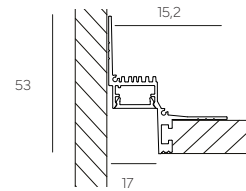
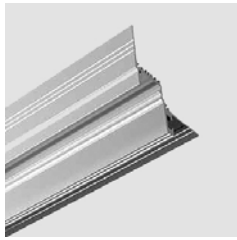

Codice base Base code	Lunghezza mm Length mm	Colore Finishes	Peso Kg Weight Kg
MPO	100 1000	W Bianco / White	0,55 kg
	200 2000	B Nero / Black	1,10 kg
	300 3000	A Anodized	1,65 kg

Profilo in alluminio estruso AW6060 completo di schermo in policarbonato opale anti-UV. Installazione ad incasso senza bordi
 AW6060 aluminium extruded profile with anti-UV opal polycarbonate diffuser. Trimless recessed installation

Accessori / Accessories



NB: Per una selezione più ampia di profili per strip LED, si invita a consultare il catalogo IN46 / For a more extensive selection of LED strip profiles, please refer to the IN46 catalogue.



Ultraslim LED Strip

238 led/mt 24V DC 9.6 W/mt CRI90 5000mm

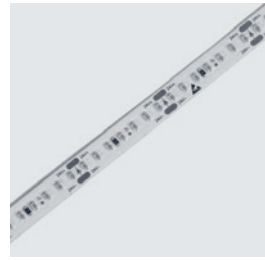

Codice / Code	CCTs	lm / mt
SS2700	2700K	860
SS3000	3000K	905
SS4000	4000K	945

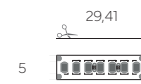

Flood LED Strip

256 led/mt 24V DC 34 W/mt CRI90 5000mm



Codice / Code	CCTs	lm / mt
SF2700	2700K	3720
SF3000	3000K	3920
SF4000	4000K	4080

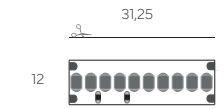

Ultraslim LED Strip

238 led/mt 24V DC 14.4 W/mt CRI90 5000mm

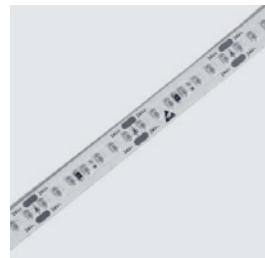

Codice / Code	CCTs	lm / mt
SV2700	2700K	1280
SV3000	3000K	1350
SV4000	4000K	1405

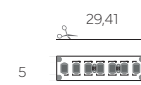

Density IP65 LED Strip

200 led/mt 24V DC 16.8 W/mt CRI90 5000mm

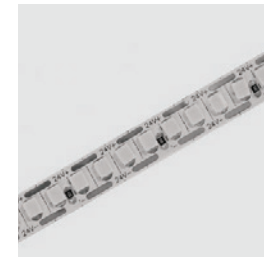

Codice / Code	CCTs	lm / mt
SW2700IP67	2700K	1900
SW3000IP67	3000K	2070
SW4000IP67	4000K	2220

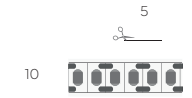

Density LED Strip

200 led/mt 24V DC 16.8 W/mt CRI90 5000mm



Codice / Code	CCTs	lm / mt
SW2700	2700K	1900
SW3000	3000K	2070
SW4000	4000K	2220

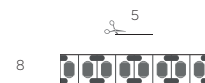

COB LED Strip

COB 220V DC 14.4 W/mt



Codice / Code	CCTs	lm / mt
SW3000	3000K	1080
SW4000	4000K	1130

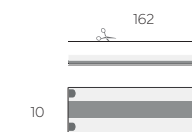

Accessori / Accessories

- SWTAP Tappo / Cap
- SWWIR Alimentazione / Feed

Density+ LED Strip

250 led/mt 24V DC 22 W/mt CRI90 5000mm



Codice / Code	CCTs	lm / mt
SK2700	2700K	2490
SK3000	3000K	2700
SK4000	4000K	2750

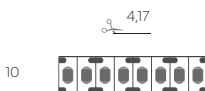

RGB+W LED Strip

COFTechnology 24V DC 16.8 W/mt CRI90 5000mm



Codice / Code	CCTs	lm / mt
COFRGB3	3000K	655 (RGB + 3000K)
COFRGB4	4000K	640 (RGB + 4000K)

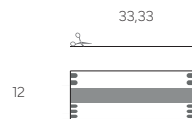

RGB+TW LED Strip

COF Tecnologia 24V DC 18 W/mt CRI90 5000mm



Codice / Code	CCTs	lm / mt
COFRGBCTC	RGBCTW	1150 (full on)

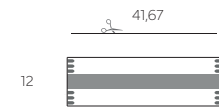

TW LED Strip

166 led/mt 24V DC 18 W/mt



Codice / Code	CCTs	lm / mt
601CTC	TW	2300 (2700K -6000K)

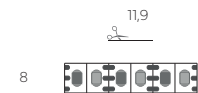

RGB LED Strip

COF Tecnologia 24V DC 14.4 W/mt 5000mm



Codice / Code	CCTs	lm / mt
COFRGB	RGB	460

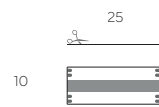

Flexy

Neon 24V DC 8 W/mt



Codice / Code	Lunghezza / Length	CCTs	lm / mt
SFWW	min 0.5 - max 5 mt	3000K	950
SFNW	min 0.5 - max 5 mt	4000K	950

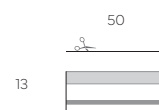

Accessori / Accessories

SFTAP	Tappo / Cap
SFWIR	Alimentazione / Feed
SFM	Clip

Alimentatori 24V / 24V Drivers

Modello / Model	P (max)	Tipologia / Type	Dimensioni / Dimension
122322	25W	Standard	136X55X19mm
127820	30W	Standard	153X42X32mm
SNP30-24VF-2	30W	Standard slim	251x24x16mm
SL60-24VF	60W	Standard slim	305x30x17mm
SL100-24VF-1	100W	Standard slim	321x30x19mm
SL150-24VF-1	150W	Standard slim	321x30x19mm
SL200-24VF	200W	Standard slim	323x60x22mm
SDL60-24VF	60W	DALI / Push slim	361x30x22mm
SDL100-24VF	100W	DALI / Push slim	336x30x19mm
SDL150-24VF	150W	DALI / Push slim	336x30x19mm
SDL200-24VF	200W	DALI / Push slim	429x32x23.5mm

Interfacce 24V / 24V interfaces

Modello / Model	P (max)	Tipologia / Type	Dimensioni / Dimension
MINI-1CV	12-48V 12A	Push - 0-10V / 1-10V - 1 CH	57X44X25mm
MINI-1CV-DALI	12-48V 10A	DALI - 1 Channel	57X44X25mm
MINI-1CV-CASAMBI	12-48V 12A	Casambi - 1 Channel	57X44X25mm
DLX1224-4CV	12/24V-4X5A (max 10A tot)	Push - 4 Channels	88X54X26mm
DLX1224-4CV-DALI	12/24V-4X5A (max 10A tot)	DALI - 4 Channels	88X54X26mm
DLX1224-4CV-CASAMBI	12/24V-4X5A (max 10A tot)	Casambi - 4 Channels	88X54X26mm
DLX-1224-4CV-DMX	12/24V-4x5A (max 10A tot)	DMX - 4 Channels	88X54X26mm
LINE-5CV-DALI	12/48V-5x5A (max 12A tot)	DALI - 5 Channels	186X29X21mm
LINE-5CV-CASAMBI	12/48V-5x5A (max 12A tot)	Casambi - 5 Channels	186X29X21mm
DRC1224-5CV	12/24V-5x3A (max 15A tot)	Telecomando - 5 Channels	114X38X20mm
DMX-T4-ZONE-B	-	DMX Control Interface - Black	120X80X37mm
DMX-T4-ZONE-W	-	DMX Control Interface - White	120X80X37mm
SDR-CCT	-	Movable Casambi Control Interface	Ø50X90mm

Appendix

Referece index

Code	Product	Pag.
0900	Sun	232
0874	Point IP	233
1138	Micro Ice	174
1148	Magic Ice	141
1150	Omnia Ice	205
1168	Ice	272
2018	KS	276
2025	Omnia Spot	200
2035	Magic K/S	131
2036	Magic Point	136
2037	Magic K/S (tracks 9635, 9665, 9650)	131
2040	Magic K/S Pendant	140
2045	Magic K/XS	130
2047	Magic K/XS (tracks 9635, 9665, 9650)	130
2048	Magic Mini	137
2050	Micro Mini	171
2066	Micro Point	170
2120	Smart E/XXS	228
2130	Smart E/XS	229
2340	C-Track S	84
2341	C-Track M	84
2342	C-Track L	85
3000	Isi 40 UGR<19	218
3001	Isi 55 UGR<19	218
3002	Isi 75 UGR<19	219
3003	Gear Round Trim UGR<10	224
3004	Gear Round Trimless UGR<10	224
3005	Gear Square Trim UGR<10	225
3006	Dot 30	210
3007	Dot 40	210
3008	Dot 55	211
3009	Dot 65	212
4830	Sun/P	232
4010	Speedway Wall Opal	294
4011	Speedway Wall Opal	294
4020	Speedway Wall Excel	295
4030	Laser Wall	299
7011	Speedway Opal L=1000	252

Code	Product	Pag.
7012	Speedway Opal L=1500	252
7021	Speedway Excel UGR<19 L=1000	252
7022	Speedway Excel UGR<19 L=1500	252
7031	Speedway Opal Bi L=1000	252
7032	Speedway Opal Bi L=1500	252
7041	Speedway Excel Bi UGR<19 L=1000	254
7042	Speedway Excel Bi UGR<19 L=1500	254
7051	Subway Opal L=1000	260
7052	Subway Opal L=1500	260
7061	Subway Excel UGR<19 L=1000	260
7062	Subway Excel UGR<19 L=1500	260
7071	Miniway Opal L=1000	246
7072	Miniway Opal L=1500	246
7081	Miniway Opal Bi L=1000	247
7082	Miniway Opal Bi L=1500	247
7091	Cycle Ø600	268
7092	Cycle Ø1000	268
7093	Cycle Ø1400	268
7094	Cycle Ø1800	268
7101	Candle L=1000	264
7102	Candle L=1500	264
7103	Candle L=2000	264
7104	Candle L=2500	264
7105	Candle L=3000	264
7111	Snake	286
8001	Magic Spot 35	125
8002	Magic Spot 45	125
8003	Magic Spot 55	126
8004	Magic Spot 70	127
8005	Otto Ø60 - Mains Voltage	74
8006	Otto Ø85 - Mains Voltage	75
8007	Otto Ø105 - Mains Voltage	76
8008	Otto Ø40 - Magic48	116
8009	Otto Ø60 - Magic48	117
8010	Otto Ø40 - Micro48	166
8011	Magic Spot 55 Zoom	126
8630	Micro48 Standard	160
8635	Micro48 Deep	161

Code	Product	Pag.
8650	Micro48 Trimless	162
9605	Mains Voltage Standard	60
9615	Mains Voltage Recessed	61
9620	Mains Voltage Trimless	64
9625	Mains Voltage H Track	62
9630	Magic48 Standard	104
9635	Magic48 Deep	105
9640	Magic48 Recessed Trimless	108
9645	Magic48 Recessed Trim	109
9650	Magic48 Recessed Trimless Deep	110
9655	Magic48 Standard	106
9665	Magic48 Deep	107
9865	Magic Linear Front Lens L=286	149
9866	Magic Linear Front Lens L=567	149
9867	Magic Linear Front Lens L=847	149
9868	Magic Linear Front Lens L=1128	149
9870	Magic Linear Front Opal L=286	148
9871	Magic Linear Front Opal L=567	148
9872	Magic Linear Front Opal L=847	148
9873	Magic Linear Front Opal L=1128	148
9874	Magic Linear Front Opal L=1408	148
9875	Magic Linear Front UGR<19 L=286	148
9876	Magic Linear Front UGR<19 L=567	148
9877	Magic Linear Front UGR<19 L=847	148
9878	Magic Linear Front UGR<19 L=1128	148
GA	Omnia GA	193
GB	Omnia GB	197
HGTR	HG Track Trimless	65
HS	HS Suspensions	280-3
HSTR	HS Track Suspended	63
JA48E	Magic Linear Excel	147
JA48O	Magic Linear Opal	146
JA48T	Magic Linear Microprismatic UGR<19	146
JAE	Omnia Excel	205
JCE	Excel Trim UGR<19	238
JGE	Excel Trimless UGR<19	238
JHE	Excel Trimless Wall Washer UGR<19	239
LED Strips	Tutte le versioni / All types	306-9

Code	Product	Pag.
LINEA	Lineatrack Opal	90
LINEB	Lineatrack Microprismatic UGR<19	90
LINES	Lineatrack Spot	91
MA	Surface Profile	303
MC	Trim Recessed Profile	303
ME	45° Corner Profile	304
MJ	Trimless Recessed Profile	303
MP	Trimless Atmosphere Lighting Profile	304
SM48E	Micro Linear Flat Excel UGR<19	178
SM48L	Micro Linear Flat Lens	179
SM48O	Micro Linear Flat Opal	178
ST48E	Magic Linear Flat Excel	150
ST48L	Magic Linear Flat Lens	151
ST48O	Magic Linear Flat Opal	150

Condizioni di vendita

1. Prodotti

ILMAS S.p.A. si riserva la facoltà di effettuare in qualsiasi momento variazioni tecniche, formali e dimensionali dei propri prodotti. La società si riserva il diritto di eliminare dalla produzione, in qualsiasi momento e senza preavviso, eventuali prodotti e, ferme restando le caratteristiche essenziali dei modelli descritti, di apportare variazioni di prezzo, modifiche di parti, dettagli o finiture che ritenga convenienti a scopo migliorativo e/o per esigenze tecniche e/o commerciali. Tutte le innovazioni, sia tecniche che formali che verranno eventualmente apportate, sono coperte da brevetto.

2. Termini di garanzia

a. ILMAS S.p.A. garantisce che i prodotti a marchio ILMAS sono esenti da vizi di fabbricazione e/o di materiale, in caso d'uso conforme alla destinazione.

Tale garanzia è rilasciata per un periodo di 60 mesi dalla data di consegna del materiale al cliente.

b. Questa garanzia dalla data di consegna dei prodotti, è rilasciata sui Prodotti standard presenti nei propri cataloghi o schede tecniche allegate all'ordine, daintendersi parte integrante delle condizioni generali.

3. Termini di consegna

a. I termini temporali di consegna riportati nell'ordine o nella fattura sono da intendersi a titolo indicativo e non perentorio; pertanto il ritardo "non

rilevante"(ovverosia quello inferiore a giorni 15 lavorativi) nell'evasione dell'ordine da parte di ILMAS S.p.A. non potrà costituire motivo di annullamento dell'ordine stesso da parte dell'acquirente e non darà diritto a quest'ultimo di richiedere a ILMAS S.p.A. alcun risarcimento e/o indennizzo di sorta né ad applicazioni di penali.

b. Nel caso si verificino cause di forza maggiore nell'evasione dell'ordine, nessuna responsabilità potrà essere addebitata a ILMAS S.p.a. che si adopererà al meglio delle sue possibilità per limitare gli effetti negativi conseguenti alla intervenuta impossibilità della prestazione.

c. L'ordine si intenderà risolto di diritto nel caso in cui l'Acquirente non provveda al ritiro della merce presso il luogo di consegna pattuito entro 15 giorni successivi alla data concordata per la consegna, con pieno diritto per ILMAS S.p.A. di richiedere il risarcimento dei danni e delle spese o, in caso di autorizzazione da parte di ILMAS S.p.A. al ritiro del prodotto successivamente al quindicesimo giorno, a ricevere un pagamento maggiorato del 10% rispetto all'ammontare originario.

4. Qualità della Merce

a. ILMAS S.p.A. garantisce che la merce consegnata è conforme alle caratteristiche prescelte dall'Acquirente; a quelle indicate nelle proprie schede tecniche e cataloghi; agli standard eventualmente prescritti dalla Legge Italiana e Comunitaria attualmente vigenti, anche in materia di sicurezza.

b. La merce fornita da ILMAS S.p.A. è esente da vizi o difetti che la rendano inidonea all'uso per cui è stata fabbricata ed a cui è normalmente destinata (uso indicato nel sito, nel catalogo e nelle schede tecniche). Qualora l'Acquirente abbia espressamente ordinato merce con particolari caratteristiche extracatalogo, non richiamate dalle schede tecniche, ILMAS S.p.A., che pure opererà con la richiesta diligenza, non si assume alcuna responsabilità per quanto possa verificarsi in conseguenza dell'utilizzo di prodotti modificati su esplicita richiesta dell'Acquirente.

c. La merce viene venduta e consegnata in imballaggi conformi alla Legge.

d. ILMAS S.p.A. non assume alcuna responsabilità sul mantenimento delle caratteristiche qualitative del prodotto fornito qualora lo stesso, dopola consegna, siastato manipolato e/o trasformato dall'Acquirente senza che quest'ultimo abbia preventivamente consultato ILMAS S.p.A. e richiesto la sua autorizzazione ad intervenire. In assenza di esplicita autorizzazione di ILMAS S.p.A., in caso di intervento dell'Acquirente, quest'ultimo perderà ogni diritto alla garanzia.

5. Reclami e diritti dell'Acquirente

a. Nel caso in cui si verificasse un vizio o difformità qualitativa tra il

prodotto consegnato e quello preventivamente ordinato, l'Acquirente dovrà darne immediata comunicazione a ILMAS S.p.A. denunciando ai sensi della normativa vigente in forma scritta, entro 8 giorni di calendario dal ricevimento della merce o dalla scoperta del fatto, i vizi e/o le non conformità rispetto alle caratteristiche tecniche indicate da ILMAS S.p.A.

b. L'Acquirente, in mancanza del reclamo formale nei termini indicati di cui sopra, decadrà dal diritto alla garanzia. In caso di reclamo, l'Acquirente dovrà in ogni caso astenersi dall'utilizzare il prodotto contestato, che dovrà essere idoneamente conservato onde consentire a ILMAS S.p.A. di poter eseguire tutti i controlli e analisi opportune sulla merce contestata.

c. In caso di fondatezza del reclamo ILMAS S.p.A. provvederà, in primo luogo, a sostituire a proprie spese il prodotto risultato non conforme o difettoso previa restituzione dell'elemento oggetto di contestazione, ovvero, a rifonderne il prezzo, ma solamente ove non fosse in grado preliminarmente di sostituirlo.

d. Nei casi di cui agli artt. 4b e 4d nessuna richiesta di risarcimento per danni

diretti e/o indiretti potrà essere avanzata dall'Acquirente nei confronti di ILMAS S.p.A. , anche in caso di fondatezza del reclamo.

e. L'eventuale presentazione di un reclamo non darà diritto all'Acquirente di risolvere immediatamente ed unilateralmente il contratto, né di sospendere od omettere in tutto e/o in parte il pagamento del prodotto.

6. Prezzi e Pagamenti

a. I prezzi di vendita dei prodotti ILMAS S.p.A. sono quelli indicati nelle fatture pro-forma o nelle fatture definitive di acquisto.

b. Le modalità ed i termini di pagamento sono quelli pattuiti e riportati nella fattura definitiva, o nella pro-forma, o nei DDT emessi da ILMAS S.p.A. .

7. Mancato o ritardato pagamento

In caso di mancato o ritardato pagamento anche parziale, rispetto alla scadenza pattuita ed indicata in fattura verranno applicate le norme di cui al D.Lgs. 09.10.2002 n.231, ivi comprese quelle attinenti la decorrenza degli interessi ed il saggio degli stessi. In tale ipotesi è altresì facoltà di Ilmas S.p.A. sospendere ogni e qualsiasi ulteriore fornitura di prodotti.

8. Privacy

a. In osservanza delle norme previste dal Regolamento UE 2016/679 e successive modifiche sulla tutela dei dati personali, le informazioni raccolte sull'Acquirente verranno utilizzate da ILMAS S.p.A., in qualità di Venditore/Responsabile, esclusivamente per fini commerciali ed amministrativi e potranno essere cancellate in qualsiasi momento, previa richiesta per iscritto dell'Acquirente.

b. Responsabile del trattamento dei dati è ILMAS S.p.A. All'Acquirente, titolare dei dati personali, sono riconosciuti i diritti previsti dal Regolamento UE 2016/679, tra cui, in particolare, il diritto di accedere ai propri dati personali, di chiederne la rettifica, l'aggiornamento e la cancellazione se incompleti o erronei, nonché di opporsi al loro trattamento per motivi legittimi rivolgendo tali richieste sempre al Venditore/Responsabile.

9. Foro competente

a. Le clausole contenute nelle presenti condizioni generali di vendita vanno interpretate alla luce del loro significato letterale e delle norme vigenti nell'ordinamento Italiano, in particolare del Codice Civile Italiano (R.D. n. 262 del 16/03/1942).

b. Pertutte le controversie derivanti dall'interpretazione, o dall'esecuzione del presente Contratto viene pattuita la competenza esclusiva del Foro di Milano.

Le presenti condizioni generali si intendono conosciute ed integralmente accettate dal Cliente per effetto della loro pubblicazione nel presente catalogo, anche ai sensi e per gli effetti di cui all'art. 1341 e 1342 cod. civ.

Terms of sale

1. Products

ILMAS S.p.A. has the right to modify their products' dimensions and technical specifics when necessary. The company has the right to stop production of eventual items whenever considered appropriate and without notification. It can change price lists and can modify finishing in order to improve the products' quality, or because of technical/commercial demand. Every innovation, both technical and formal, will be patented.

2. Warranty conditions

a. ILMAS S.p.A. Guarantees that the Products carrying the ILMAS brand are free from manufacturing and/or material defects in the event of compliance at destination. This Guarantee is issued for a period of 60 months from the date the material is delivered to the Customer.

b. This Guarantee from the Product delivery date is issued on standard Products present in their catalogues or technical sheets attached to the Order, to be considered an integral part of general terms and conditions.

3. Terms Of Delivery

a. Delivery data stated in order confirmation or invoice must be considered approximate and not peremptory. Therefore, "non-relevant" delay (less than 15 working days) on a shipment, can't be considered a valid reason to cancel the order; moreover, the customer is not allowed to ask for refund, due compensation or penal implementation.

b. In the event of force majeure occurring in the execution of the order, no responsibility may be charged to ILMAS S.p.a., which shall do its best to limit the negative effects resulting from the intervening impossibility of performance.

c. The order will be considered null and void whenever the buyer won't collect the goods within 15 days from the arranged delivery place and date. ILMAS S.p.A. has the right to ask for damage refund; it has also the right to authorize the pick up after the established 15 days, but the customer will be asked to pay an extra 10% on the original amount.

4. Quality Of The Goods

a. ILMAS S.p.A. guarantee that the goods' quality is in compliance with what requested by our customer and with what stated in technical data sheets and catalogues. The quality is in compliance also with Italian and EU legal standards and their security matters.

b. Our goods are free from faults that make them unsuitable for their use (usage is described on the website, on the catalogue and on data sheets). Whether the customer asked for a particular product, which is not described neither on the catalogue nor on data sheets, ILMAS S.p.A. will do its best to accomplish the request but it won't take any responsibility for what may happen as a consequence of their use.

c. Goods are sold in packaging in compliance with the terms of law.

d. ILMAS S.p.A. won't take any responsibility on products that have been modified by the customer himself, without asking the company's opinion and without receiving its approval. Without the authorization in modifying the item from the part of ILMAS S.p.A., the product will lose its warranty.

5. Rights And Complaints Of The Costumer

a. The customer must advise ILMAS S.p.A. on every fault or dissimilarity between the delivered item and the one ordered; the company must be

informed, in written form, within 8 days from the reception of the goods (or from the identification of the fault).

b. Whether the customer won't signal the inconformity within the terms stated above, he will lose the warranty terms. In case of complaint, the customer must not use the item. The last must be

kept in proper conditions, in order to enable ILMAS S.p.A. to proceed with analysis and quality check.

c. Once ILMAS S.p.A. will have proved the complain, it will replace the faulty item on its behalf; the faulty item must be returned to the company. If necessary, ILMAS S.p.A. will die cast the product from its origins.

d. Considering articles 4b and 4d, the customer can't ask for refund for direct or indirect damages, even though the complaint is established.

e. The complaint won't allow the customer neither to annul the contract, nor to dismiss the payment, or part of it.

6. Prices And Terms Of Payment

a. ILMAS S.p.A. trade costs are those stated in proforma and invoices.

b. Terms of payment are agreed before the purchase and then stated in our proforma, bills of landing and invoices.

7. Lacking or delayed payment

In case of lacking or delayed payment with reference to the arranged due date, being it total or partial, the company will apply rules of D.Lgs 09.10.2002 n.231, considering also the overdue interests. In this case, Ilmas S.p.A. is also entitled to suspend any and all further supply of products.

8. Privacy

a. According to 2016/679 U and following revisions, ILMAS S.p.A. will use responsibly its customers' information just for commercial and administrative purposes. Information may be cancelled at any time under the customer's request.

b. ILMAS S.p.A. is the only responsible for use of personal data. All costumers, owners of personal data, have the rights quoted in 2016/679 UE Regulation. In particular: they can have access to their own personal data; they can ask for amendment, update or elimination whether data result incomplete or wrong; they have the right to forbid the company from using personal data, for any legal reason, through a written request .

9. Court In Charge

a. Clauses stated in the present terms of sale have to be intended in their literal meaning according to Italian set of rules, Codice Civile Italiano (R.D. n. 262 dated 16/03/1942).

b. For eventual litigation derived from wrong interpretation, the court in charge is the one of Milano.

These general terms and conditions shall be deemed to be known and fully accepted by the Customer by virtue of their publication in this catalogue, also pursuant to and for the purposes of Articles 1341 and 1342 of the Civil Code.

Condizioni di garanzia

1. ILMAS S.p.A. garantisce che i prodotti a marchio ILMAS sono esenti da vizi di fabbricazione e/o di materiale, in caso d'uso conforme alla destinazione.
Tale garanzia è rilasciata per un periodo di 60 mesi dalla data di consegna del materiale al cliente.

2. La garanzia è rilasciata dalla data di consegna del materiale, sia sui Prodotti presenti nei nostri cataloghi attualmente in corso di validità, sia su esecuzioni speciali di Prodotti custom.

3. Durata della Garanzia:
GARANZIA STANDARD: La Garanzia Standard è valida per tutti i prodotti con marchio ILMAS S.p.A., per la durata di 5 anni o comunque per la durata di utilizzo di 50.000 ore dalla data dell'acquisto.

4. La Garanzia opera alle seguenti condizioni:

a) Il Prodotto sia stato regolarmente pagato in conformità alle condizioni di pagamento concordate nel contratto di vendita.

b) Il Prodotto venga usato in conformità alle specifiche tecniche predisposte, relative al Prodotto e all'impiego per il quale è stato costruito, come riportato su foglio d'istruzione, catalogo e scheda tecnica.

c) L'installazione del Prodotto venga eseguita da personale tecnico specializzato, in conformità alle norme impiantistiche in vigore.

d) Il Prodotto non venga esposto a carichi meccanici non conformi alla destinazione dello stesso.

e) Il Prodotto deve essere installato in ambienti in cui i valori massimi di temperature, di umidità relativa e di tensioni non siano superati.

f) L'etichetta di identificazione posta sul Prodotto non venga alterata o rimossa.

g) La manutenzione e/o la riparazione del Prodotto venga eseguita da personale tecnico specializzato e non vengano effettuate modifiche o riparazioni al Prodotto senza specifica autorizzazione da parte di ILMAS S.p.A.

h) Qualsiasi malfunzionamento, debitamente specificato nella sua natura ed entità, venga denunciato dal Cliente per iscritto tramite la compilazione dell'apposito modulo, inviato ad ILMAS S.p.A. entro e non oltre 10 (dieci) giorni lavorativi dal manifestarsi dello stesso, pena la decadenza.

Nel caso in cui il Prodotto dovesse rivelare vizi coperti dalla presente dichiarazione di Garanzia, e sempre che si verifichino le condizioni esposte nei paragrafi precedenti, ILMAS S.p.A. sarà libera di procedere, a sua discrezione, alla riparazione e/o sostituzione del Prodotto con un prodotto uguale o equivalente, nuovo o rigenerato, con l'obiettivo di ricostruire le condizioni di funzionamento ottimale del Prodotto.

Sia in caso di riparazione che di sostituzione del Prodotti o componenti elettrici difettosi, continuerà a valere lo stesso termine di garanzia originale, il quale non dovrà intendersi rinnovato.

5. Esclusioni di Garanzia:

La Garanzia non opera con riferimento a:

a) i vizi del Prodotto dovuti a eventi imprevisi e imprevedibili, c.d. caso fortuito e/o forza maggiore (comprese, in via meramente esemplificativa, scariche elettriche, fulmini, sovratensioni sopra i limiti di norma, eventi naturali), che escludano la riconducibilità di tali vizi al processo di fabbricazione del Prodotto.

b) I vizi derivanti da disturbi impulsivi (surge) di ampiezza o durata superiori a:
- 1000 V tra conduttore e conduttore (L e N)
- 1000 V tra conduttore e terra (L e PE, N e PE).

c) Se a seguito di una verifica dell'impianto i parametri rilevati risulteranno differenti da quelli indicati da ILMAS S.p.A. nella propria documentazione tecnica.

d) Tutte le spese accessorie che scaturiscono in seguito alla riparazione del vizio (come p.es. quelle per il montaggio e lo smontaggio del prodotto, il trasporto del reso del Prodotto e l'invio del Prodotto riparato e/o nuovo; lo smaltimento, le eventuali trasferte di personale per la riparazione e/o sostituzione del prodotto, dispositivi di sollevamento, impalcature scc.); spese saranno a carico del Cliente.

e) Tutte le parti soggette ad usura, quali per esempio le batterie, le parti meccaniche/plastiche soggette a naturale invecchiamento del materiale.

f) Malfunzionamenti derivanti dalla mancata manutenzione del prodotto.

g) Malfunzionamenti derivanti dall'utilizzo o dall'installazione di componenti del prodotto non forniti da ILMAS S.p.A.

h) Danni causati dal trasporto, dall'utilizzo delle apparecchiature in condizioni ambientali inadeguate, da negligenza nella manutenzione, da tentativi di riparazione eseguiti da personale non specializzato e/o non autorizzato da ILMAS S.p.A., con l'utilizzo di accessori o parti di ricambio non originali.

i) L'eventuale acquisto di prodotti vuoti non cablati.

6. Legge applicabile:

le condizioni della presente garanzia commerciale non costituiscono in alcun modo una esclusione, limitazione o variazione dei diritti del cliente derivanti dalla garanzia legale di conformità. Nell'esecuzione di prestazioni in garanzia ILMAS S.p.A. è responsabile soltanto, per qualsivoglia fondamento giuridico, nei termini indicati nelle condizioni generali di vendita e di consegna in vigore al momento in cui la garanzia commerciale viene prestata: in tutti gli altri casi è esclusa qualsiasi responsabilità risarcitoria. La presente garanzia è disciplinata dal diritto italiano, con esclusione della Convenzione delle Nazioni Unite sui contratti di vendita internazionale di merci (CISG). Il foro competente per tutte le controversie derivanti dalla presente garanzia è quello di Milano Italia.

Guarantee conditions

1. ILMAS S.p.A. guarantees that ILMAS branded products are free from manufacturing and/or material defects when used as intended. This warranty is issued for a period of 60 months from the date of delivery of the material to the customer.

2. The warranty is issued from the date of delivery of the material, both on Products in our catalogs currently in force and on special executions of custom Products.

3. Duration of Warranty:
STANDARD WARRANTY: The Standard Warranty is valid for all products bearing the ILMAS S.p.A. trademark, for the duration of 5 years or otherwise for the duration of use of 50,000 hours from the date of purchase.

4. The Warranty operates under the following conditions:

a) The Product has been duly paid for in accordance with the payment terms agreed to in the sales contract.

b) The Product is used in accordance with the technical specifications prepared, pertaining to the Product and the use for which it was manufactured, as stated on the instruction sheet, catalog, and data sheet.

c) The installation of the Product is carried out by specialized technical personnel, in accordance with the plant engineering standards in force.

d) The Product is not exposed to mechanical loads not in accordance with its intended purpose.

e) The Product shall be installed in environments where the maximum temperature, relative humidity and voltage values are not exceeded.

f) The identification label placed on the Product is not altered or removed.

g) Maintenance and/or repair of the Product is carried out by specialized technical personnel and no modifications or repairs are made to the Product without specific authorization from ILMAS S.p.A.

h) Any malfunction, duly specified in its nature and entity, is reported by the Customer in writing by filling out the appropriate form, sent to ILMAS S.p.A. no later than 10 (ten) working days from the occurrence of the same, under penalty of forfeiture.

In the event that the Product should reveal defects covered by this Warranty statement, and provided that the conditions set forth in the preceding paragraphs are met, ILMAS S.p.A. shall be free to proceed, at its discretion, to repair and/or replace the Product with an equal or equivalent product, new or remanufactured, with the aim of reconstructing the Product's optimal operating conditions.

In the event of both repair and replacement of the defective Product or electrical components, the same original warranty term shall continue to apply, which shall not be deemed renewed.

5. Warranty Exclusions:

The Warranty does not operate with respect to:

a) Product defects due to unforeseen and unforeseeable events, so-called fortuitous events and/or force majeure (including, but not limited to, electrical discharges, lightning strikes, surges above normal limits, natural events), which exclude the traceability of such defects to the manufacturing process of the Product.

(b) Defects resulting from impulsive disturbances (surges) of

amplitude or duration exceeding:

- 1000 V between conductor and conductor (L and N)
- 2000 V between conductor and ground (L and PE, N and PE).

c) If, following an inspection of the installation, the parameters detected are different from those indicated by ILMAS S.p.A. in its technical documentation.

d) All incidental expenses that arise as a result of the repair of the defect (such as, for example, those for the assembly and disassembly of the product, the transport of the return of the Product and the sending of the repaired and/or new Product; disposal, any travel of personnel for the repair and/or replacement of the product, lifting devices, scaffolding scc.); expenses will be borne by the Customer.

e) All parts subject to wear and tear, such as for example batteries, mechanical/plastic parts subject to natural aging of the material.

f) Malfunctions resulting from failure to maintain the product.

g) Malfunctions resulting from the use or installation of product components not supplied by ILMAS S.p.A.

h) Damage caused by transportation, use of the equipment in unsuitable environmental conditions, negligence in maintenance, repair attempts performed by non-specialized personnel and/ or not authorized by ILMAS S.p.A., with the use of non-original accessories or spare parts.

(i) The possible purchase of unwired empty products.

6. Applicable Law:

the terms of this commercial warranty shall in no way constitute an exclusion, limitation or variation of the customer's rights under the legal warranty of conformity. In the performance of services under warranty, ILMAS S.p.A. shall be liable only, for any legal basis whatsoever, under the terms set forth in general conditions of sale and delivery in force at the time the commercial warranty is provided: in all other cases, any liability for damages is excluded. This warranty is governed by Italian law, to the exclusion of the United Nations Convention on Contracts for the International Sale of Goods (CISG).

The place of jurisdiction for all disputes arising from this warranty is Milan Italy.

Credits

Creative Direction & Editorial

Ilmas Team

Acknowledgement

Collina Luxury Relais, Tecnoarreda Srl, Clusone – Italy pag. 70-71, 266
Company Headquarters LTransport SpA, Arch. G. Rigano, L&D Luci e Design SRL, Pescara – Italy pag. 124, 270, 272
Company Headquarters, Tel Aviv – Israel pag. 284-285
Company Headquarters Ilmas, Garbagnate Milanese – Italy pag. 25, 26, 34-35, 144, 194
Exhibition Space, Emilia-Romagna – Italy pag. 82-83, 92-93
Fashion Store, Piemonte – Italy 123, 305
Furniture Showroom, Arch. Ido Corradini, Cagliari – Italy pag. 278
Ilmas Exhibition Booth Euroluce23, Milano – Italy pag. 138, 269, 292
Ilmas Exhibition Booth Light & Building, Frankfurt – Germany pag. 262, 265, 289
Legal Firm Avvocato Re, Patrizia Pirovano Architetto, Erba – Italy pag. 152-153
Lightmap Studio, Milano – Italy pag. 244-245, 250-251, 255, 258-259, 261
Photography Exhibition Michael. Kenna, S. Lodesani Studio, Reggio Emilia – Italy pag. 180-181
Private Residence, Beirut - Lebanon pag. 236
Private Residence, Milano – Italy pag. 48-49, 234, 296
Private Residences, Mannheim & Various Cities - Germany pag. 132,134, 142, 213, 216, 222, 230, 274, 289, 302
Sportswear Store, Bex – Switzerland pag. 80-81, 226
Storm Club, Arc. Luigi Bulgarelli, Monza – Italy pag. 88-89
The Lift Gym, Arc. Luigi Bulgarelli, Biassono – Italy pag. 72-73, 214
Womenswear Fashion Store, Milano – Italy pag. 128
Womenswear Fashion Store, Roma – Italy pag. 78

The logo for Ilmas, featuring the word "ilmas" in a bold, lowercase, sans-serif font. The letter "i" is lowercase, while "lmas" are uppercase. The "l" is very thick and has a slight curve at the top. The "m" and "a" are also thick and blocky. The "s" is lowercase and has a curved tail.

Print

O.G.M. Printing S.p.A.
April 2024

© Ilmas S.p.A.

All rights reserved

ARC_01

Product book
04/2024 vers.1

I dati presenti all'interno del catalogo hanno validità alla data della stampa. Ilmas S.p.A. si riserva la facoltà di apportare variazioni tecniche e dimensionali ai propri prodotti. Per eventuali aggiornamenti e per scaricare le ultime versioni del presente documento collegarsi al sito www.ilmas.com

The informations in this catalogue are valid on the date of printing. Ilmas S.p.A. reserves the right to make technical and dimensional changes to its products. For any updates and to download the latest versions of this document, go to www.ilmas.com

Ilmas S.p.A.

Via Giovanni Falcone, 7
20024 Garbagnate Milanese MI
+39 0293900 349
+39 0293900 353
ilmas@ilmas.com